

PIONEER



**SOLID STATE STEREO AMPLIFIER
MODEL**

SA-900

CAUTION

Before connecting the line cord to the wall socket, carefully read and follow the instructions shown below, to assure the safety of your unit.

- Model SA-900 is set to 240V operation when shipped. If this unit is used in a different line-voltage area, read and follow "LINE VOLTAGE SELECTION AND FUSE" on Page 1. Be sure that the line voltage setting on your unit agrees with the line voltage in your area and that the fuse installed in your unit is a proper one.

INSTALLATION, OPERATING AND SERVICE MANUAL

Including PARTS LIST, CIRCUIT DIAGRAMS AND MOUNTING TEMPLATE.

< FV, FA >

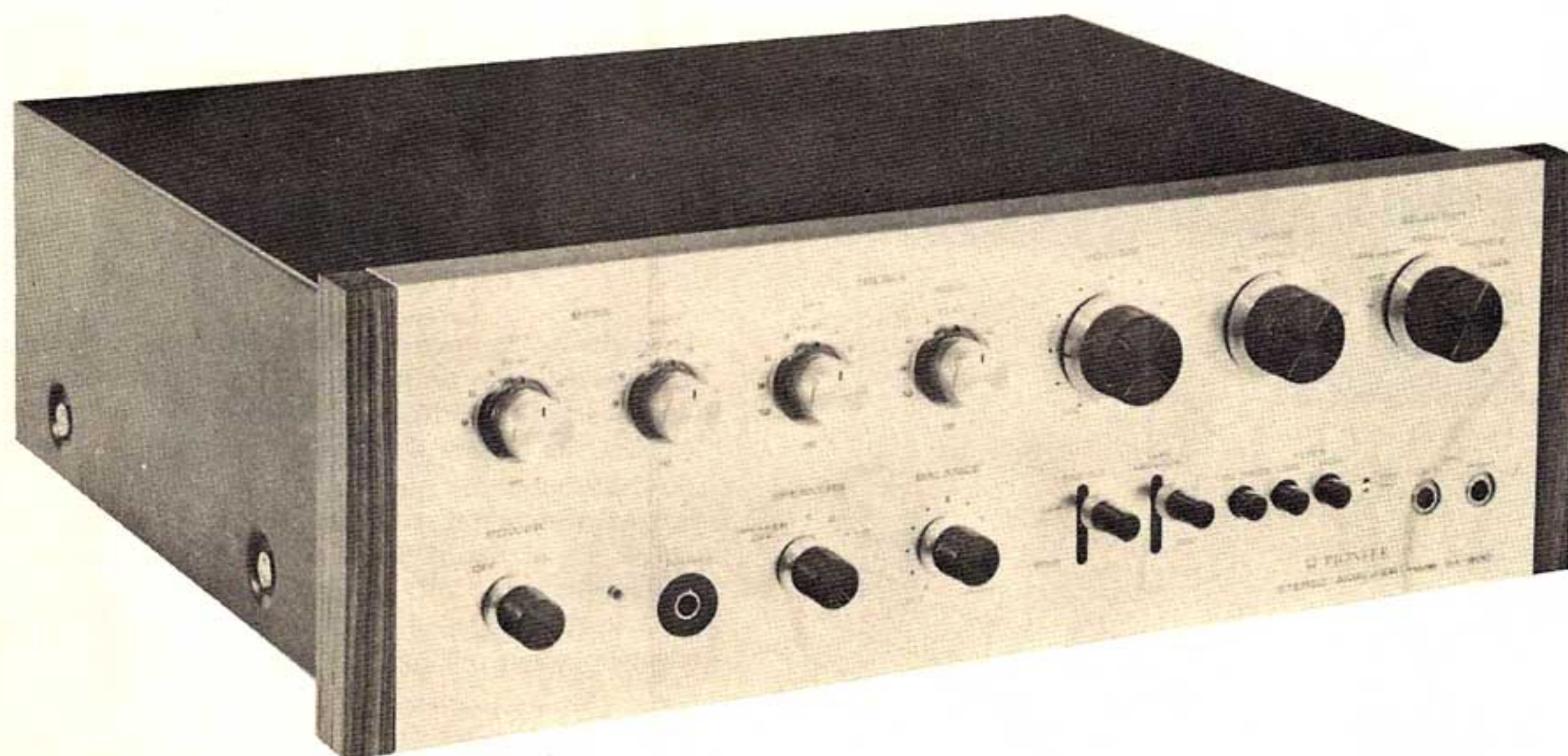

PIONEER ELECTRONIC CORPORATION

FEATURES

● HIGH-PERFORMANCE PREAMPLIFIERS AND POWER AMPLIFIERS FOR LARGE POWER OUTPUT:

An output with minimum distortion and maximum margin is obtained by the complementary SEPP circuit which uses triple diffusion silicon transistors.

● EXTREMELY HIGH SIGNAL-TO-NOISE RATIO:

The head amplifiers use carefully selected low-noise transistors; therefore, the signal-to-noise ratio is higher than that of any other equipment of this class.

● ACCURATE EQUALIZER CHARACTERISTIC:

The direct-coupled three-stage equalizer circuit system by E-E feedback gives a highly accurate and stable equalizer characteristic.

● MOVING COIL CARTRIDGE CAN BE USED:

In addition to those for the conventional MM, CERAMIC and CRYSTAL cartridges, input terminals are provided for the MOVING COIL cartridge which is highly reputed among

audio lovers. Thus a variety of cartridges can be used, and their performances can be compared for audition by switch operation.

● FET-USING CONTROL AMPLIFIERS

A high-performance FET is used in the first stage of the control circuits. The input impedance is high, and stable performance can be obtained.

● MULTI-STEP SWITCH SYSTEM TONE CONTROLS:

Precision tone control circuits in which elements in the NFB circuit are switched are used for accurate tone control of 3 dB per step. Furthermore, the level of the medium range is not fluctuated by tone adjustment.

● VARIOUS ACCESSORY MECHANISMS:

A loudspeaker selector switch that permits use of two sets of loudspeaker systems is provided. In addition, a mode switch, muting switch, low/high filter switch, and tape monitor switch are provided for optimum and versatile operation.

INSTALLATION

Select the place of installation giving due consideration to the following:

- Avoid a place which is exposed to direct sunlight, or near a space heater or other heat generating object.
- Select a place that has especially good ventilation because the SA-900 contains high-power amplifiers. Do not set it in a small space such as a bookshelf
- Avoid a moist or dusty place.
- Do not set the SA-900 on an unstable floor or a place incurring vibrations.

LINE VOLTAGE SELECTION AND FUSE

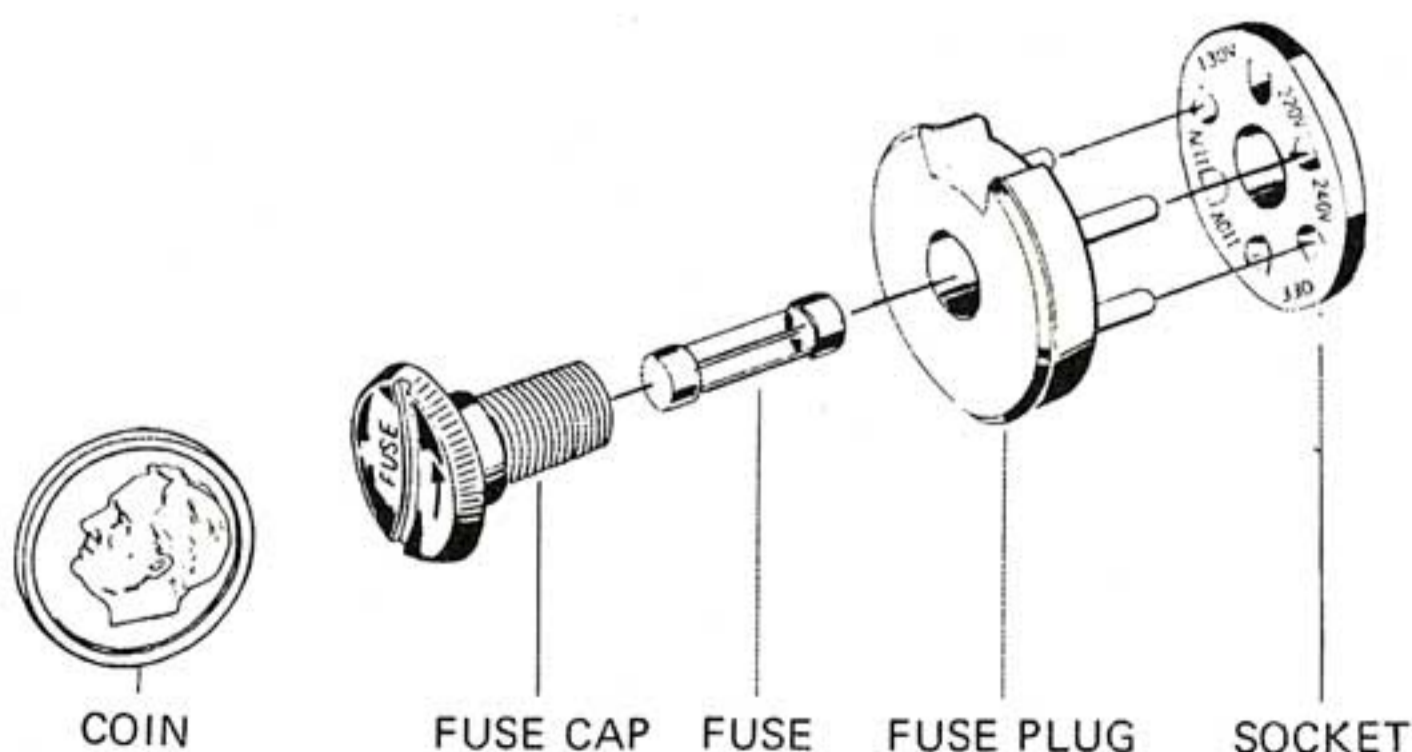

In order to remove the fuse, turn the cap located on the line voltage selector switch in the direction indicated by an arrow. Then remove the fuse plug from the unit. Put the fuse plug back so that the proper line voltage marking can be seen thru the cut on the edge of the plug.

Whenever the set position of the selector switch is changed, check the rating of the fuse. A 1.5-ampere fuse is to be used for either 220 V or 240 V operation and a 3-ampere fuse for any of 110 V, 117 V, or 130 V operation. If the rating of the fuse is proper, install the fuse on the fuse cap.

REPLACING OF FUSE

When the fuse is blown off, remove the fuse cap and replace the fuse with a new one.

Take off the fuse cap by turning it with a coin, etc. in the direction indicated by the arrow mark.



COMPOSITION OF STEREO SYSTEM

The SA-900 is a stereo preamplifier and POWER amplifier system. By connecting loudspeaker systems, record players and other instruments to it as shown in Fig. 1 to Fig. 4, a high-performance stereo system can be composed.

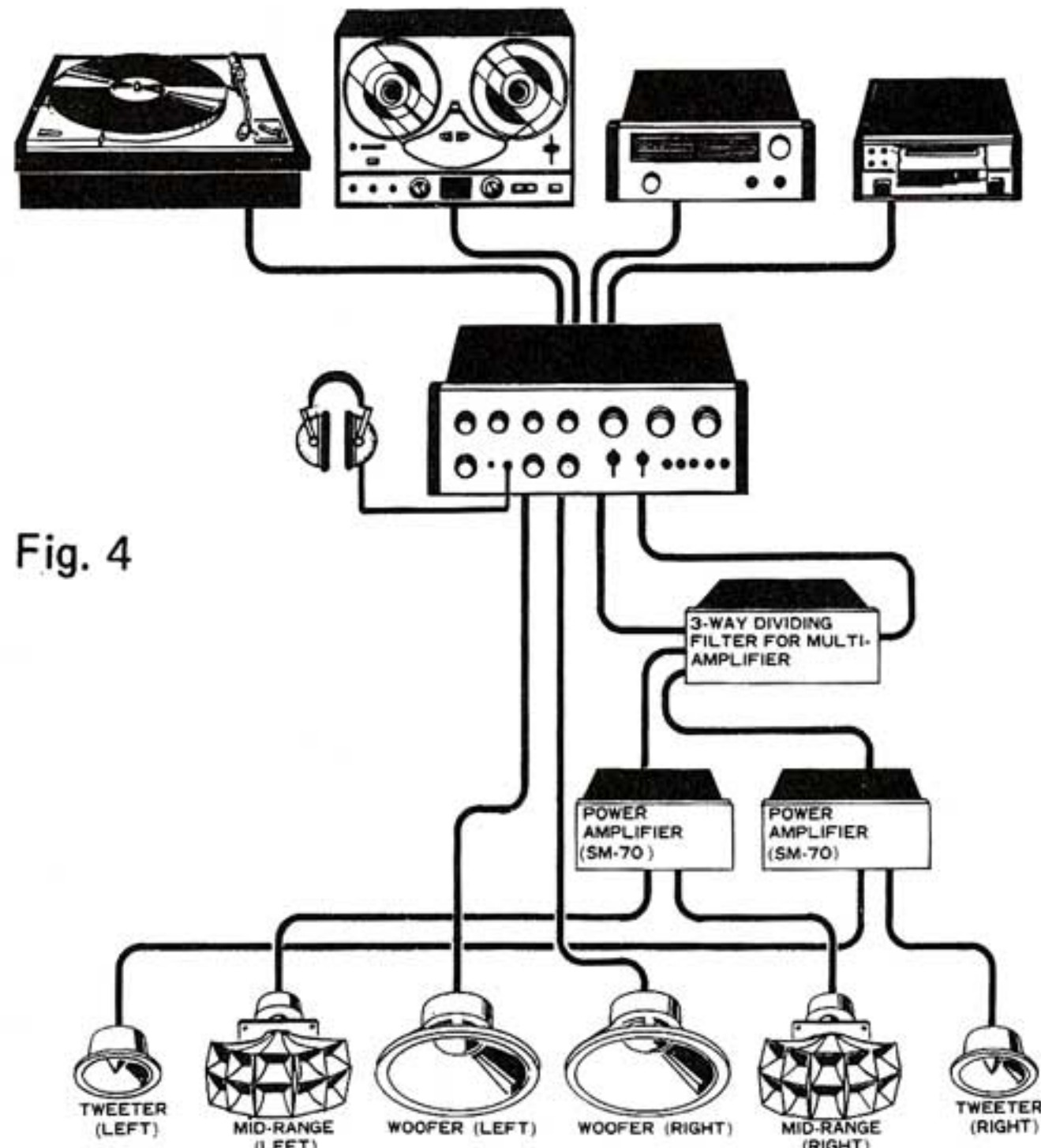
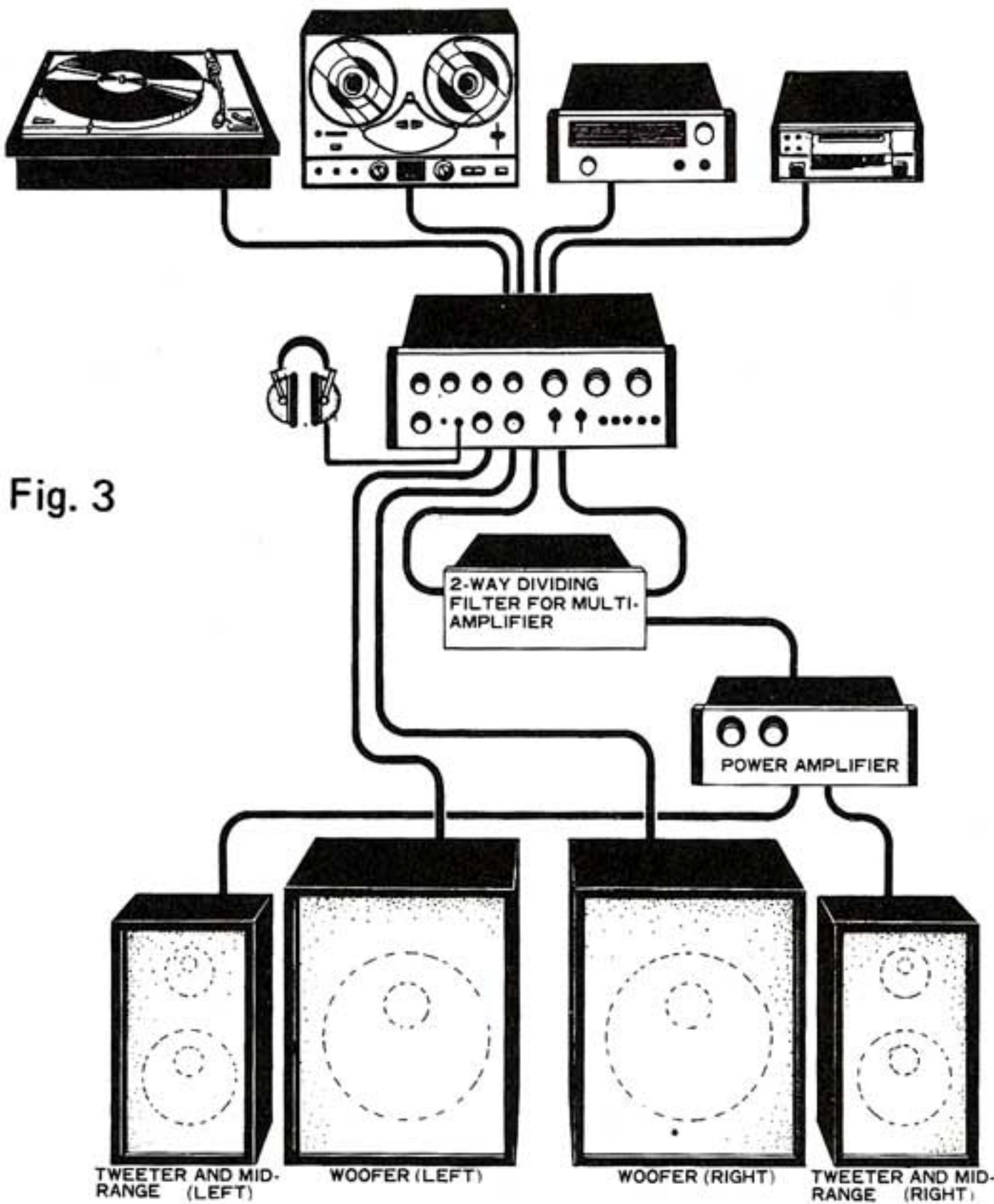
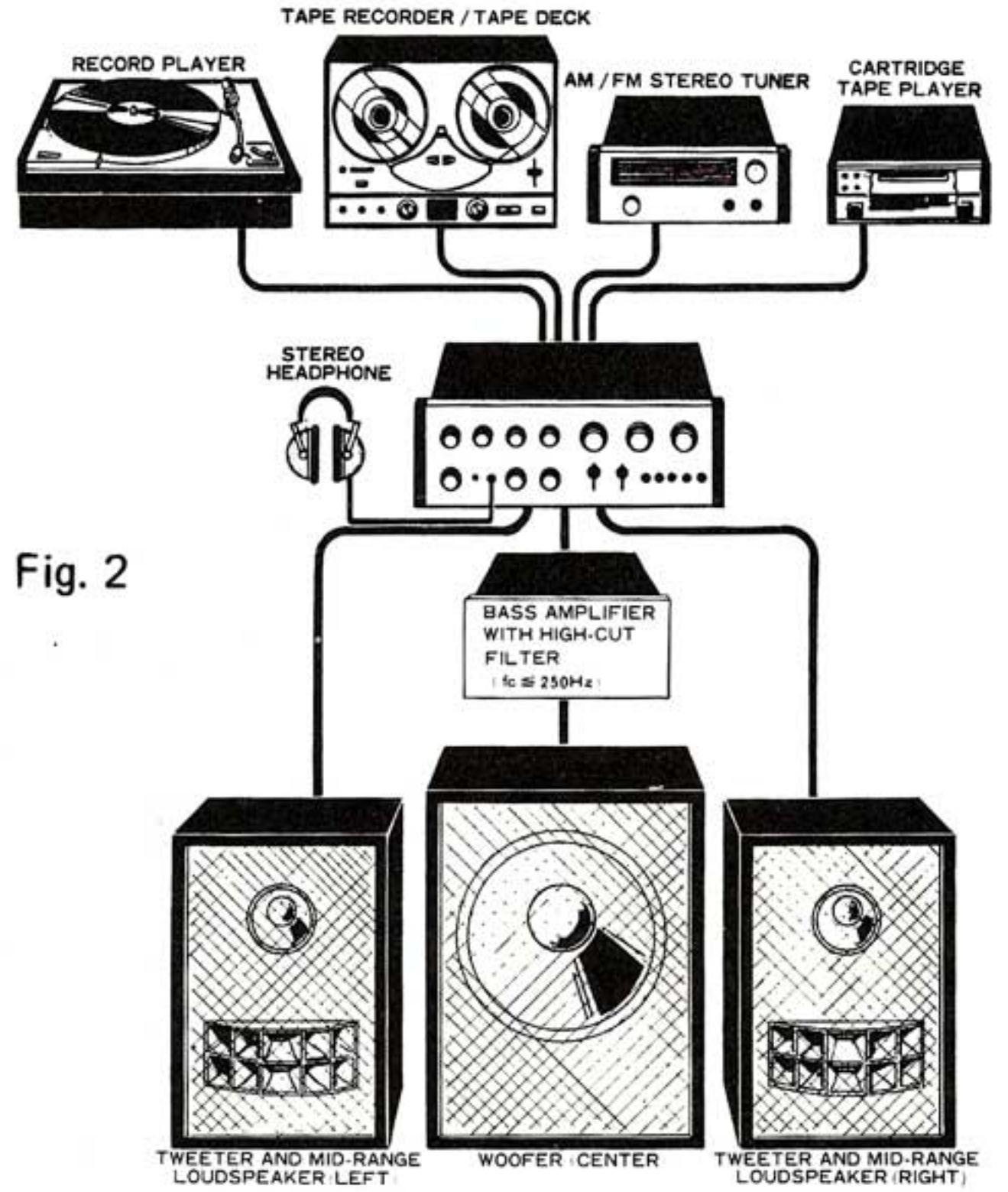
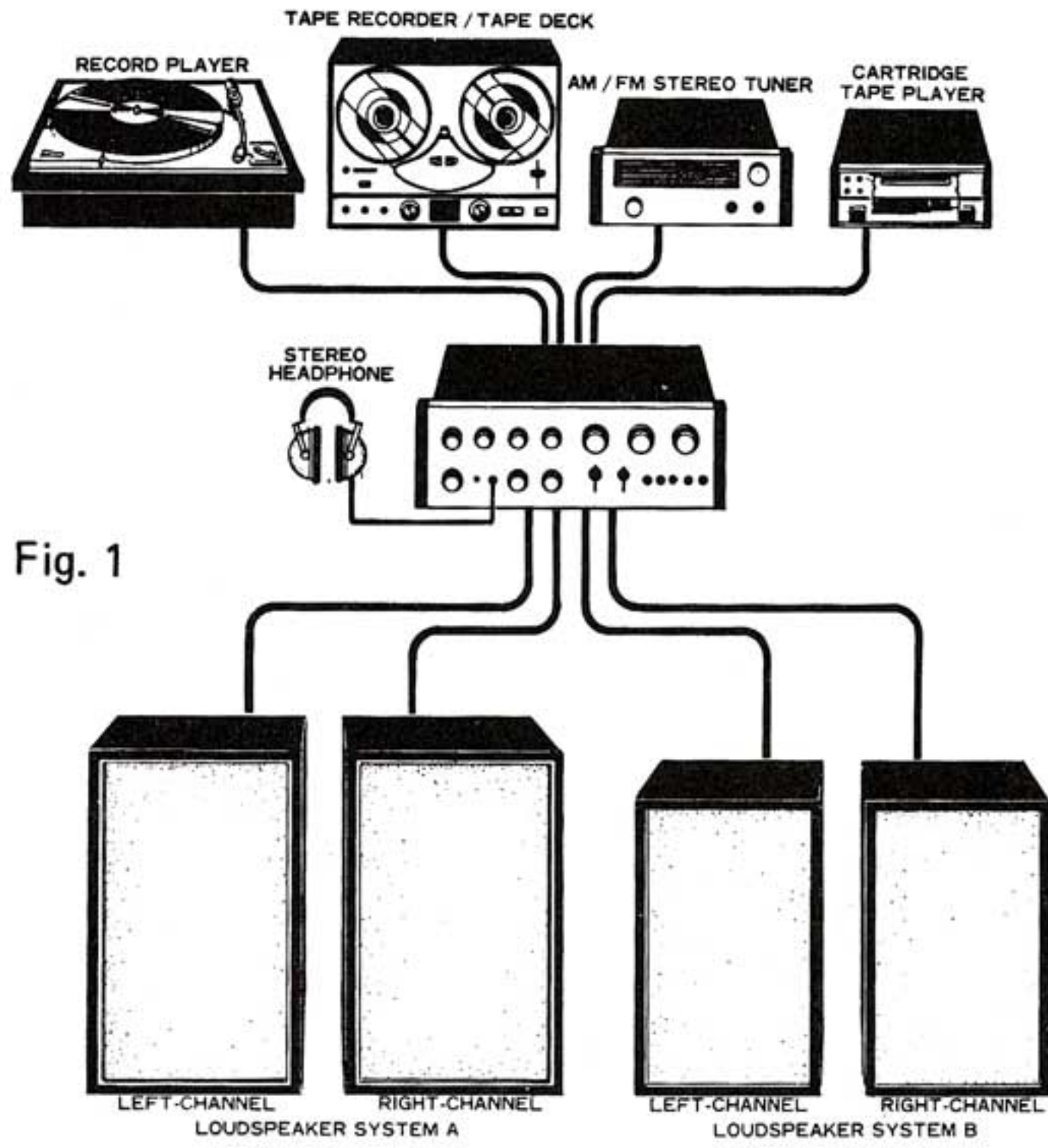

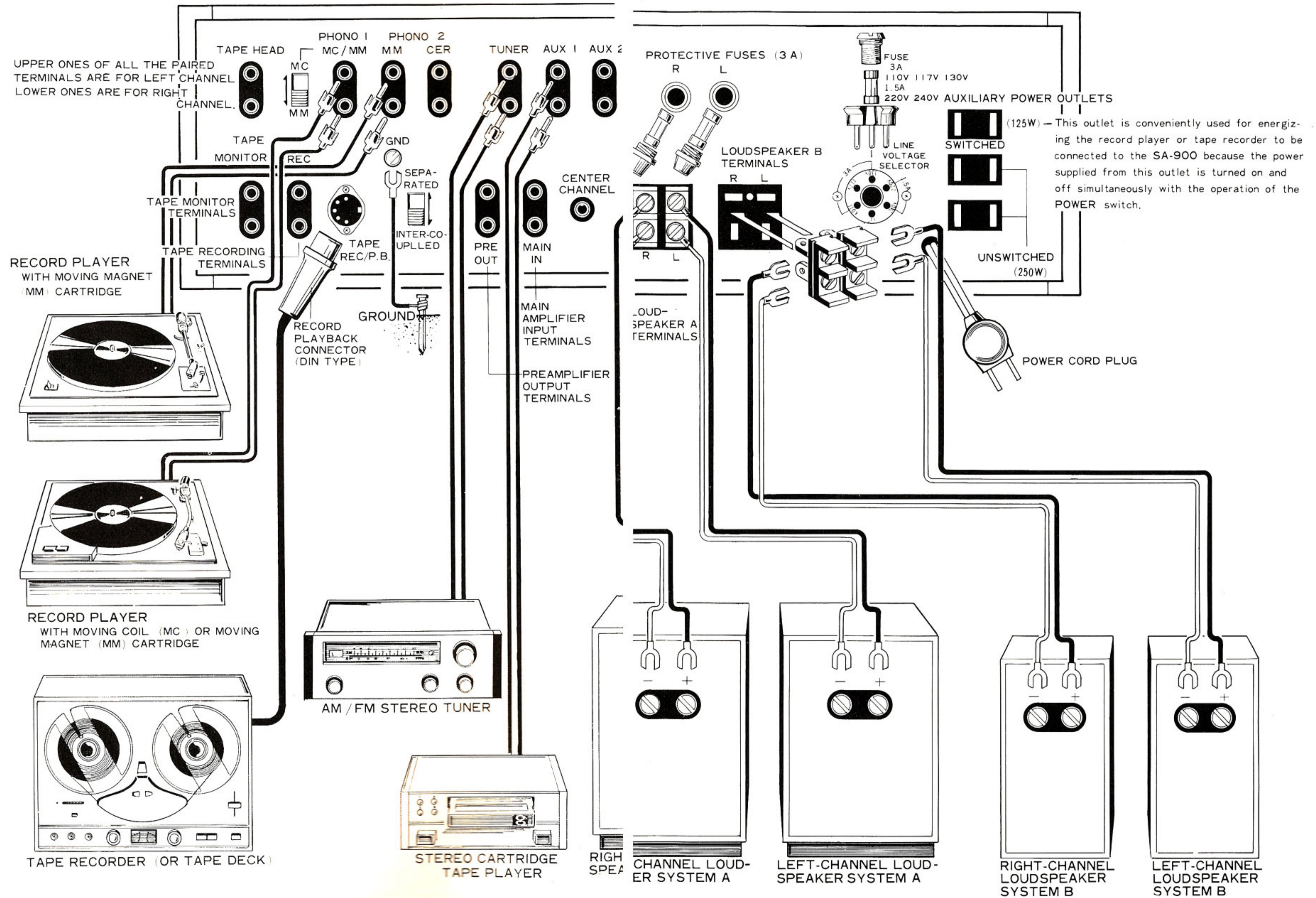

CONTROLS AND SWITCHES ON FRONT PANEL

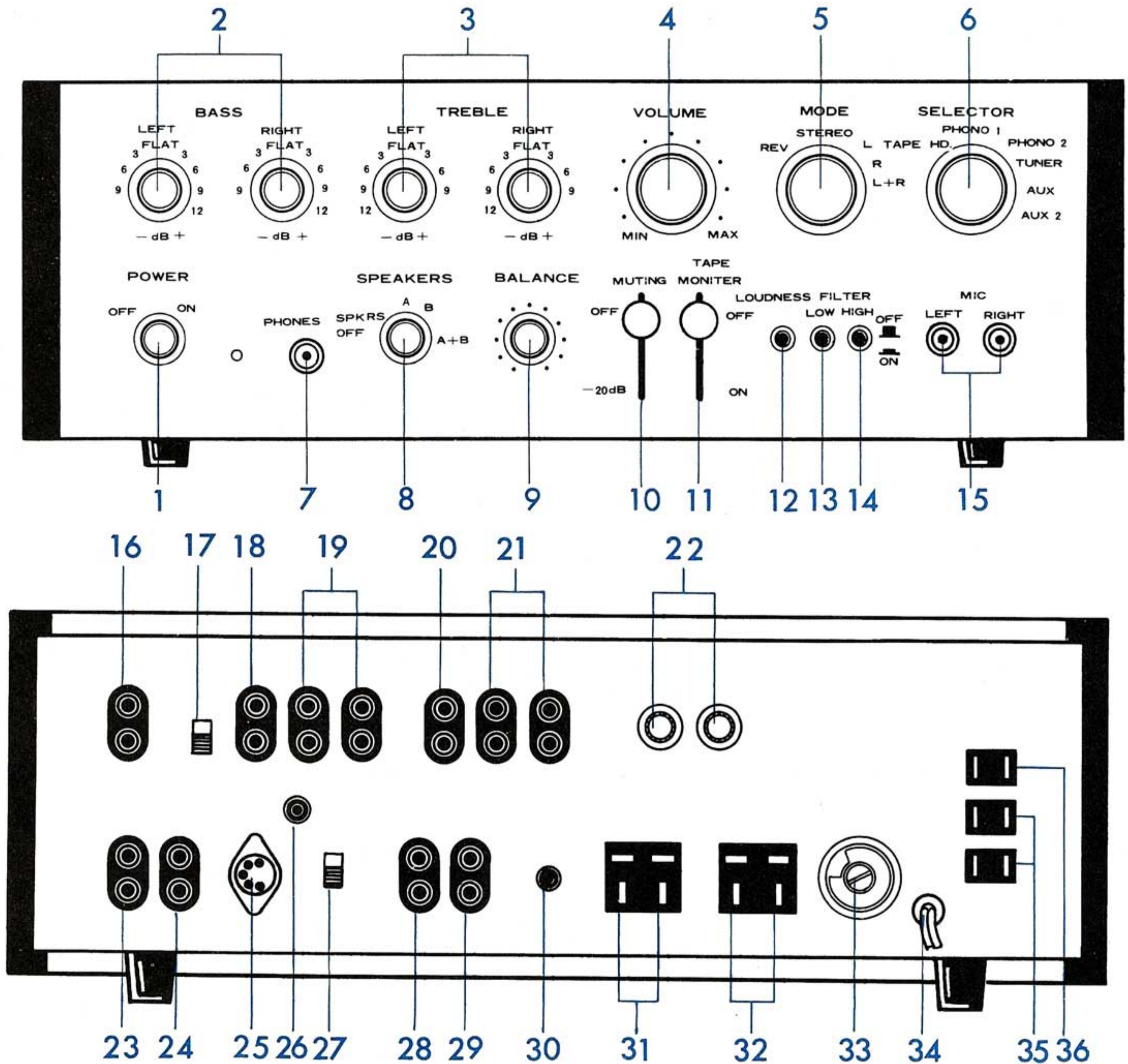

1. POWER SWITCH

The on-off switch. Turn it clockwise to ON, and the SA-900 will be energized. Simultaneously with the on-off operation of this switch, power obtained from the AC outlet (36) located on the rear panel is turned on and off.

2. BASS CONTROLS

Bass controls. When the knob is turned clockwise from FLAT,

bass is boosted; when turned counterclockwise, attenuated. The LEFT knob is for the left channel; the RIGHT knob, for the right channel. The graduation is in decibels (dB) for direct reading of the level boosted or attenuated.

3. TREBLE CONTROLS

Treble controls. Their operation is similar to that of the bass controls.

4. VOLUME CONTROL

The control for adjusting the sound volume. When the knob is turned clockwise, the volume increases; when turned counterclockwise, it decreases.

5. MODE SWITCH

Stereo or monaural play is selected as below when the knob is set to the respective positions;

- REV Stereo operation with the signals of right and left channels exchanged for each other.
- STEREO Normal stereo operation
- L Monaural operation with input signal of the left channel only.
- R Monaural operation with input signal of the right channel only.
- L + R Monaural operation with signals of right and left channels mixed together.

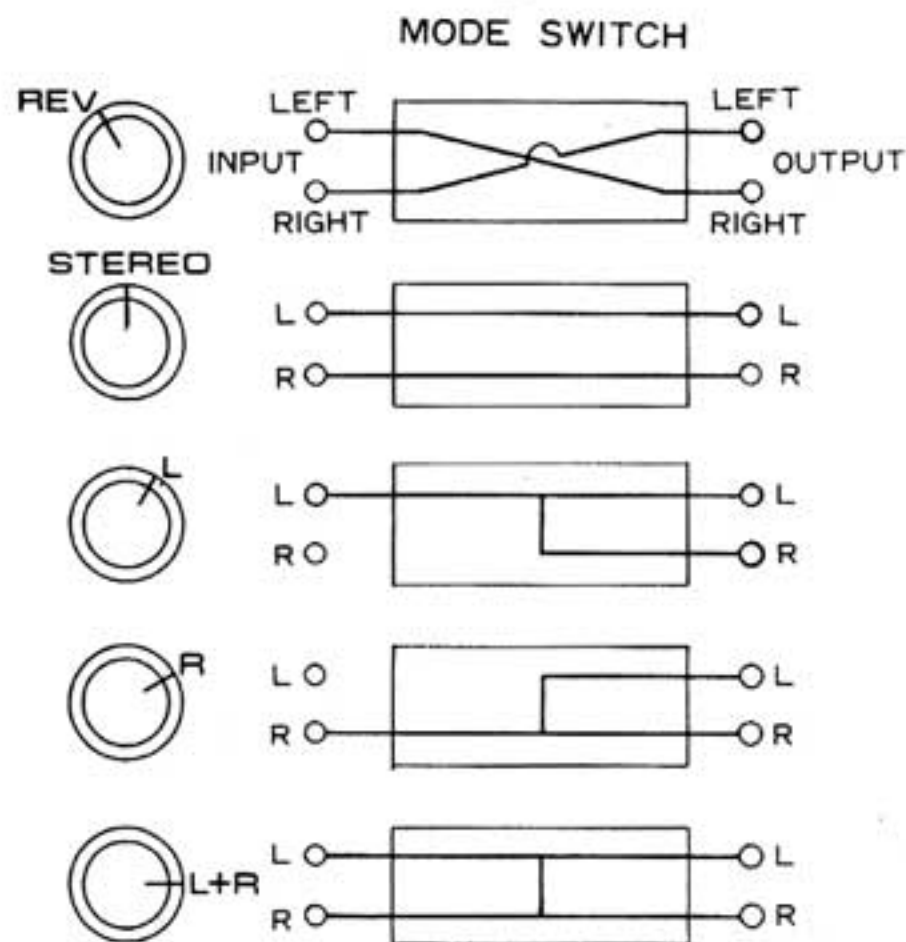

6. SELECTOR SWITCH

The switch to select the record player, tape playback, radio tuner or other output to be fed into the SA-900.

- MIC When using microphones.
- TAPE HEAD When reproducing tape head output directly.
- PHONO 1 When using the record player connected to the PHONO 1 terminals.
- PHONO 2 When using the record player connected to the PHONO 2 terminals.
- TUNER When receiving a radio program through a radio tuner.
- AUX 1 When using the instrument (for example, a cartridge tape player) connected to the AUX 1 terminals.
- AUX 2 When using the instrument connected to the AUX 2 terminals.

7. PHONES JACK

Stereo headphone connecting jack. The cord plug of the headphone separately available will be inserted here. Signal can be extracted from this jack at any time; therefore, it is convenient for monitoring a stereo concert. By setting the SPEAKERS switch (8) to the SPEAKERS OFF position, you can listen to music by yourself through the headphone.

8. SPEAKERS SWITCH

The switch to turn off and select loudspeakers as follows:

SPEAKERS OFF All loudspeakers are turned off. This position is convenient when listening through the headphone.

- A The loudspeaker system connected to the SPEAKER A terminals (31) is turned on.

- B The loudspeaker system connected to the SPEAKER B terminals (32) is turned on.
- A + B The loudspeaker systems connected to the SPEAKER A and B terminals are turned on simultaneously.

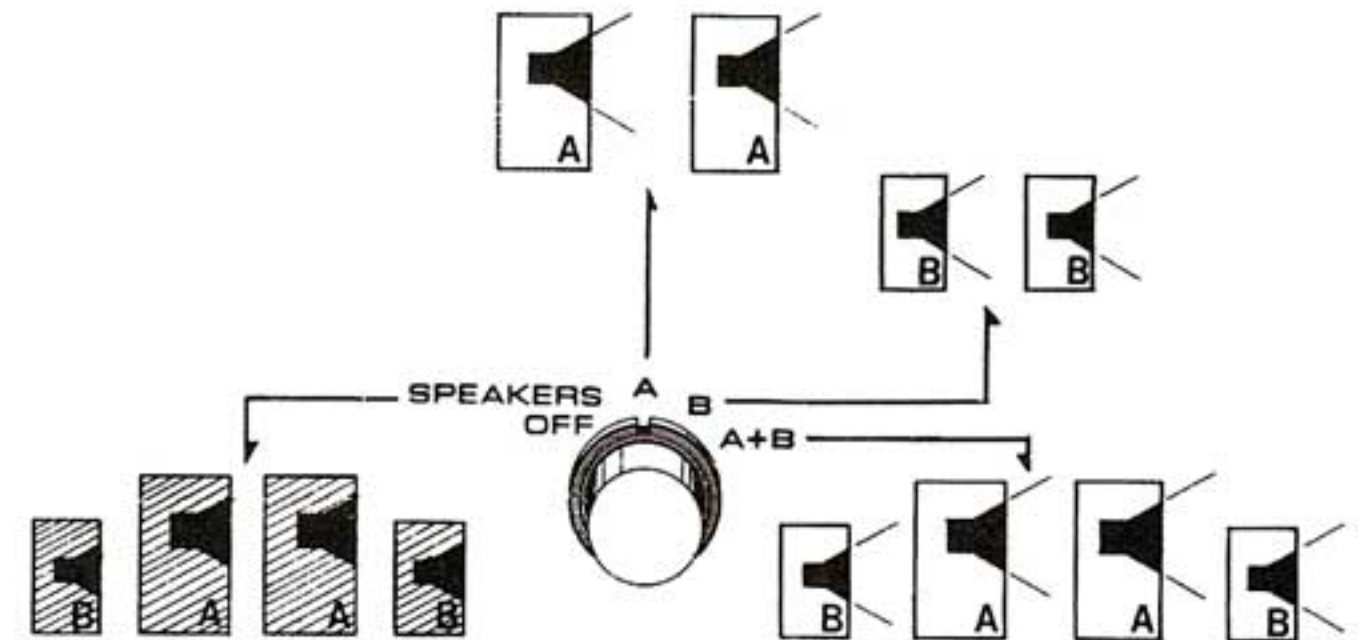

9. BALANCE CONTROL

The knob to balance the sound volumes of the loudspeaker systems placed on right and left sides. When the knob is turned counterclockwise from the center, the volume of the right-side loudspeaker system decreases; when turned clockwise, the left-side loudspeaker system decreases.

10. MUTING SWITCH

When the knob is pressed down (to the -20 dB position), the sound volume is attenuated to 1/10 (-20 dB). The normal sound volume is resumed when the knob is pushed back to the OFF position.

11. TAPE MONITOR SWITCH

Set the knob to the ON position when playing back a tape by using a tape recorder or a tape deck (having playback preamplifiers). For ordinary operation, keep the knob in the OFF position, or the loudspeakers will not sound.

NOTE: By turning this switch on and off while making a recording, the recording condition can be monitored. For details, refer to page 11.

Switches 12, 13 and 14 are pushbutton type. When the button is depressed once, the switch turns on. When the button is pressed again and let go, it comes up and the switch turns off.

12. LOUDNESS

Turn on this switch to operate the equipment at a small sound volume. Keep it turned off to operate the equipment at a large volume.

13. FILTER LOW

The switch for suppressing noise of low frequencies. When motor noise or hum is irritating, turn on the switch.

14. FILTER HIGH

The switch for suppressing noise of high frequencies. Turn it on when noise caused by a fluorescent lamp is irritating.

15. MIC JACKS

When using microphones, connect them to these jacks. The jack marked LEFT is for the left channel; that marked RIGHT is for the right channel.

NOTE: Upper ones of terminals 16, 18, 19, 20, 21, 23, 24, 27, 28, 29 are for the left channel; lower ones are for the right channel.



16. TAPE HEAD

If the tape deck to be used is not equipped with playback preamplifiers, connect the head output to these terminals directly.

17. MC/MM SWITCH

When using a moving coil (MC) cartridge with the record player connected to PHONO 1 terminals (18), set this switch to the MC position.

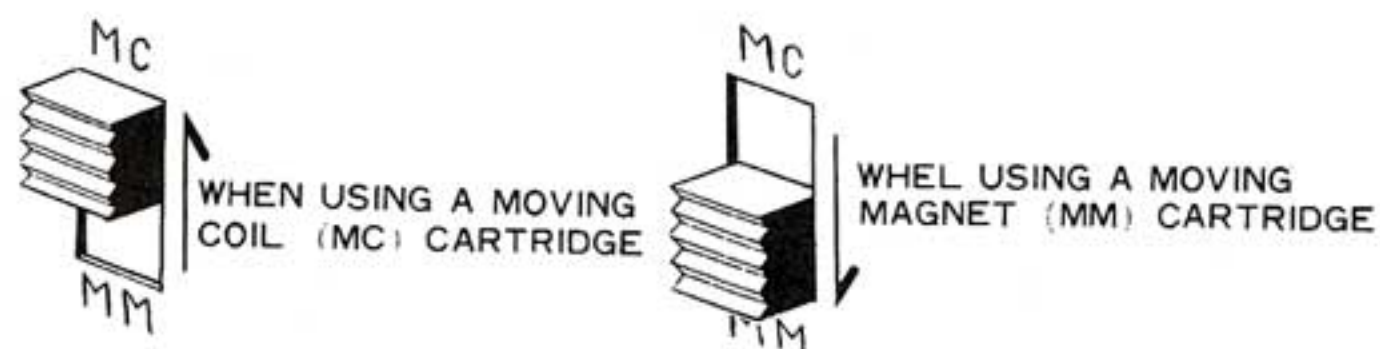

18. PHONO 1

Connect a record player with magnetic cartridge (MC or MM) to these terminals.

19. PHONO 2

When using another record player besides the one connected to PHONO 1 terminals, connect it to these terminals. If the record player is equipped with an MM cartridge, connect it to the left-hand-side terminals (marked MM). If the record player is equipped with a crystal or ceramic cartridge, connect it to the right-hand-side terminals (marked CER). The MM and CER terminals cannot be used at the same time.

20. TUNER (tuner input terminals)

Connect the output of an AM/FM stereo tuner to these terminals. If the tuner is monaural, connect it to either the upper or lower one of the terminals.

21. AUX 1, AUX 2 (auxiliary input terminals)

The output of cartridge tape player and the audio output of a television receiver may be connected to these terminals. When using two radio tuners, connect one of them to these terminals.

22. PROTECTIVE FUSES

These fuses protect transistors in the equipment. When they blow out, loudspeakers will not sound. So if loudspeakers don't work, check these fuses, and if they have blown, replace them with new 3-ampere fuses. The fuse marked RIGHT is for the right channel; the one marked LEFT is for the left channel.

23. TAPE MONITOR (tape playback terminals)

Connect the playback output terminals (LINE OUT or MONITOR) of the tape recorder or tape deck to be used, to these terminals.

24. TAPE REC (recording output terminals)

Connect the recording input terminals (LINE INPUT) of the tape recorder or tape deck to be used, to these terminals.

25. TAPE REC/P.B. (DIN type recording/playback connector)

If the tape recorder (or tape deck) is provided with a connector of the same type as this one, connection for recording and playback can be accomplished simultaneously by using the recording/playback cord separately available. When this connector is used, connection to TAPE MONITOR (23) or TAPE REC (24) is unnecessary.

26. GND (ground terminal)

Connect the grounding conductor of the record player or other instruments to be used, to this terminal.

27. PRE & MAIN (preamplifier and main amplifier separator switch)

To permit use of the SA-900^e as a component of a multi-amplifier system, the preamplifier unit and main amplifier unit can be separated from each other by setting this switch to the SEPARATED (upper) position, then the PRE OUT (28) and MAIN IN (29) terminals described below can be used.

When using the SA-900^e as an ordinary preamplifier/main amplifier unit, keep the switch in the INTERCOUPLED (lower) position.

28. PRE OUT (preamplifier unit output terminals)

When the PRE & MAIN switch (27) is set to SEPARATED (upper position), the output of preamplifiers can be taken out from these terminals. Then the SA-900^e can be used as high-performance preamplifiers. When using the SA-900^e as a component of a multi-amplifier system, connect these terminals to the input terminals of the dividing filter.

29. MAIN IN (main amplifier unit input terminals)

When the PRE & MAIN switch (27) is set to SEPARATED (upper position), these terminals are used as the input terminals of the main amplifiers in the SA-900^e. When using the SA-900^e as a component of a multi-amplifier system, connect these terminals to the output terminals of the dividing filter.

30. CENTER CHANNEL (center channel output terminal)

When composing a 3D stereo system, connect this terminal to the low-frequency range amplifier having a high-cut filter. Also, a center channel monaural amplifier may be connected to this terminal in order to prevent the hall effect.

31. SPEAKER-A (loudspeakers A terminals)

Connect the accessory plugs to the leads of loudspeaker system, then insert the plugs in these terminals. Connect the right channel loudspeaker system to the terminals marked R; the left channel loudspeaker system to those marked L.

32. SPEAKER-B (loudspeakers B terminals)

When using another loudspeaker system in addition to the one connected to the SPEAKER A terminals, connect it to these terminals. The connecting procedure is similar to that for the SPEAKER A terminals.

33. LINE VOLTAGE SELECTOR AND FUSE HOLDER

This is a line voltage selector which also serves as a fuse holder. When resetting the equipment to a different line voltage or replacing the fuse, follow the instructions described under "LINE VOLTAGE SELECTION AND FUSE", page 1

34. POWER CORD

35. AC OUTLETS (auxiliary power outlets)

Outlets for supplying AC power to tape recorder and other instruments. A maximum of 250 watts can be supplied from the two outlets. The power supplied from these outlets does not turn on or off when the POWER switch (1) is operated.

36. AC OUTLET (auxiliary power outlet)

The power supplied from this outlet turns on and off when the POWER switch (1) is operated. A maximum of 125 watts can be supplied to a record player or other instrument.

CONNECTION AND INSTALLATION OF LOUDSPEAKER SYSTEM

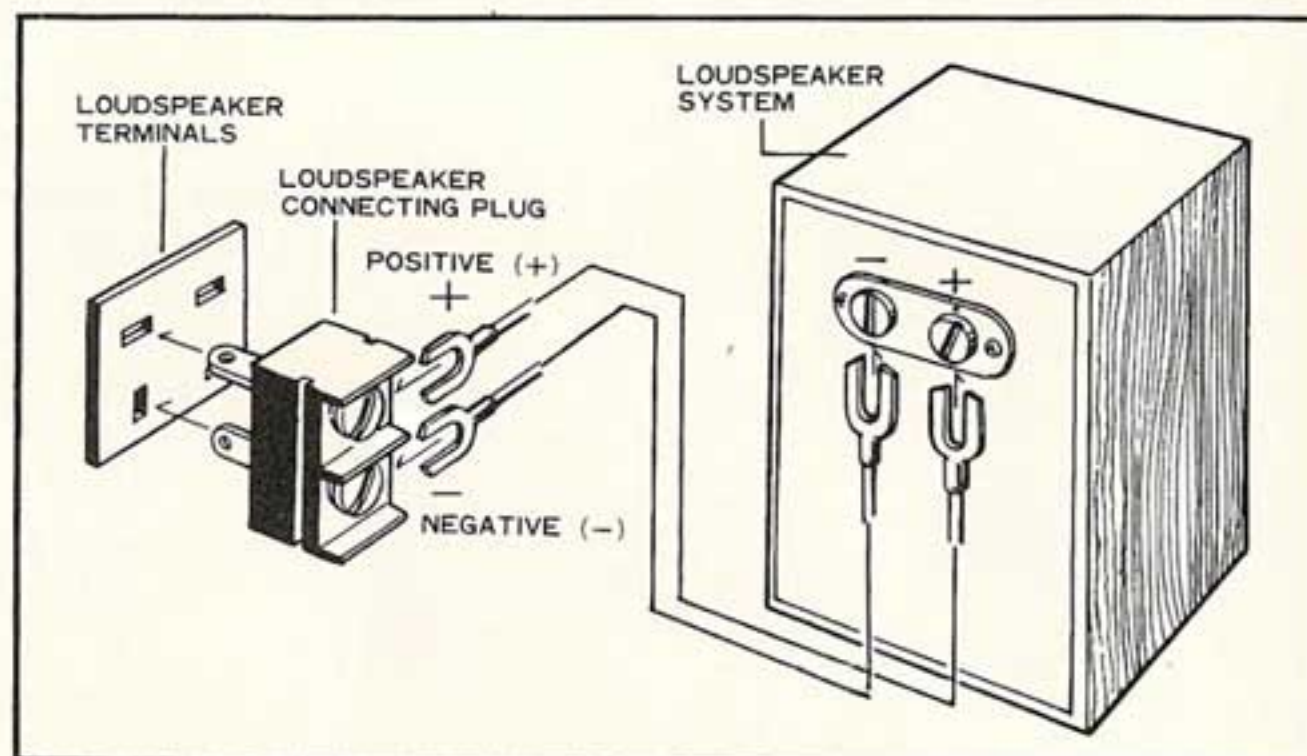

Fig. 5

• CONNECTION

1. Connect accessory loudspeaker plugs to the leads of loudspeaker system, as shown in Fig. 5. Loudspeaker leads have polarity [positive (+) and negative (-)] so connect them correctly. If positive and negative leads are shorted, a fault may result.
2. When using one loudspeaker system, use the SPEAKER A terminals (31). Connect the right channel loudspeaker system (which will be placed on the right-hand side as viewed from the front) to the terminals marked R, and the left channel loudspeaker system (which will be placed on the left-hand side) to the terminals marked L.
3. When using an additional loudspeaker system, connect it to the SPEAKER B terminals (32) similarly to the system connected to the SPEAKER A terminals (31). When using two loudspeaker systems, both systems should have an impedance of 8Ω or higher, respectively. If the impedance is lower than 8Ω , it may cause a fault in the equipment.

• INSTALLATION

The maximum stereo effect can be obtained when right and left loudspeaker systems are placed 3-1/4 to 8-1/4 feet (1 to 2.5m) apart from each other, and the listener is at the vertex of the equilateral triangle that has as a base the line drawn between the two loudspeaker systems. Right and left loudspeaker systems should be set at about the same height. If their heights are much different from each other, the stereo effect may be reduced.

CONNECTION AND OPERATION OF RECORD PLAYER

• CONNECTION

1. According to the type of cartridge used, record players are sorted as follows:

a. Moving coil (MC) type	}	Magnetic type
b. Moving magnet (MM) type		
c. Ceramic or crystal type		

Connect the output of MC or MM type record player to the PHONO 1 terminals (18). And, in case of the MC type, set the MC/MM switch (17) to the MC position; in case of the MM type, to the MM position. The upper one of the PHONO 1 terminals is for the left channel; the lower one is for the right channel.
2. When desiring to use two record players, use the PHONO 2 terminals (19) for the additional record player. If the additional record player is MM type, connect it to the PHONO 2 MM terminals (left-hand side). If the player is ceramic or crystal type, connect it to the PHONO 2 CER terminals (right-hand side). An MC-type record player cannot be connected to the PHONO 2 terminals (19).



- The output cord plugs of some record players, with the exception of all PIONEER record players, do not fit the input terminals of the SA-900 . In this case, replace the plugs with the pin plugs contained in the accessories bag.

● OPERATION

1. Verify the following before turning on the POWER switch (1):
 - a. The VOLUME control (4) is set to MIN (the knob is turned full counterclockwise).
 - b. The MODE switch (5) is set to STEREO.
 - c. The SELECTOR (6) is set to PHONO 1 or PHONO 2.
 - d. The SPEAKERS switch (18) is set to A.
 - e. The BALANCE control (9) is set to the middle.
 - f. The MUTING switch (10) is set to OFF.
 - g. The TAPE MONITOR switch (11) is set to OFF.
 - h. LOUDNESS (12), FILTER LOW (13) and FILTER HIGH (14) switches are set to OFF.
2. Turn on the POWER switch, then operate the record player to start playing.
3. Adjust the sound volume and tone quality with the VOLUME (4), BASS (2) and TREBLE (3) controls and the LOUDNESS switch (12).

CONNECTION AND OPERATION OF TUNER OR CARTRIDGE TAPE PLAYER

1. Connect the output of radio tuner to the TUNER terminals (20). The upper one of the terminals is for the left channel: the lower is for the right channel. When using an AM radio tuner, connect it to either the upper or lower one of the TUNER terminals.
2. When using an additional tuner, connect its output to the AUX 1 or 2 terminals (21).
3. For connection of a cartridge tape player such as PIONEER's H-60, use the AUX 1 or 2 terminals (21).

● OPERATION

1. Set the SELECTOR (6) to TUNER, AUX 1 or AUX 2.
2. Operate other controls and switches in the same manner as when operating a record player.

CONNECTION AND OPERATION OF TAPE RECORDER OR TAPE DECK.

- There is no problem in connection of a tape recorder to the SA-900 . However, some tape decks such as PIONEER's T-500 have recording/playback preamplifiers built-in, while others do not. When using a tape deck which does not have such built-in preamplifiers, connect the playback head output directly to the TAPE HEAD terminals (16). The following describes the connection of a tape recorder or a tape deck which has built-in preamplifiers:

● CONNECTION

1. If the tape recorder or tape deck is provided with a recording/playback connector (DIN type), connect it to the TAPE REC/P.B. connector (25) by using the recording/playback cord separately available, then connections for recording and playback can be effected simultaneously.



2. If the tape recorder or tape deck is not provided with a recording/playback connector, connect it as follows:
 - a. CONNECTION FOR RECORDING
Connect the recording input terminals (LINE INPUT) of the tape recorder or tape deck to the TAPE REC terminals (24). The upper one of the TAPE REC terminals is for the left channel; the lower is for the right channel. If the tape recorder or tape deck is monaural, connect it to either the upper or lower one of the terminals.
 - b. CONNECTION FOR PLAYBACK (OR MONITOR)
Connect the playback output terminals (LINE OUT or MONITOR) of the tape recorder or tape deck to the TAPE MONITOR terminals (23). The connecting procedure is similar to that for recording.

● OPERATION

1. RECORDING
Operate the SA-900 similarly to the ordinary operating procedure. For adjustment of the recording level, use the controls equipped on the tape recorder or tape deck in use. The VOLUME (4), BASS (2) and TREBLE (3) controls of the SA-900 are unrelated to the recording operation.
2. PLAYBACK
 1. Turn on the TAPE MONITOR switch (11).
 2. Operation of other controls and switches is similar to the procedure for operation of record player, except that the SELECTOR (6) may be set to any one of the positions.

NOTE: If the tape deck does not have playback preamplifiers built-in, set the SELECTOR (6) to TAPE HEAD, and the TAPE MONITOR switch (11) to OFF. Other operations are similar to those for record player operation.

LISTENING ROOM

- When the SA-900 has been installed, connect external instruments to it and operate the stereo system as instructed in this manual.
- Reproduced sound is considerably affected by the size of the room and the arrangement of furniture there. Generally, sound

fills the room if it has a low ceiling and a hard floor, or has a short depth and a hard wall opposite the loudspeakers. In the former case, the condition can be improved by laying a carpet on the floor; in the latter case, by hanging a thick curtain along the wall. It is also effective to rearrange the furniture so that reproduced sound may be reflected diffusely.

MICROPHONE JACKS

- Connect microphone cord plugs to the MIC terminals (15) and set the SELECTOR (6) to the MIC position. Two microphones may be used for stereo recording. For announcement or paging, one microphone is sufficient. When using only one microphone, set the MODE switch (5) to the L or R position corresponding to the MIC LEFT or RIGHT jack to which the microphone is connected.

TONE CONTROLS

- By using the BASS controls (2), the level at 100Hz can be varied from -9 to +12 dB in 3-dB steps. With the TREBLE controls (3), the level at 10 kHz is variable from -12 to +9 dB in 3-dB steps. The SA-900 causes no level fluctuations in the medium frequency range when the BASS (2) or TREBLE (3) controls are adjusted, resulting in sound reproduction of superior tone quality.

MUTING SWITCH

- When desiring to decrease the sound volume temporarily, set the MUTING switch (10) to the -20 dB position. Then the sound volume attenuates to 1/10 (-20 dB) without using the VOLUME control (4). To resume the normal volume, reset the switch to the OFF position.

TAPE MONITOR SWITCH

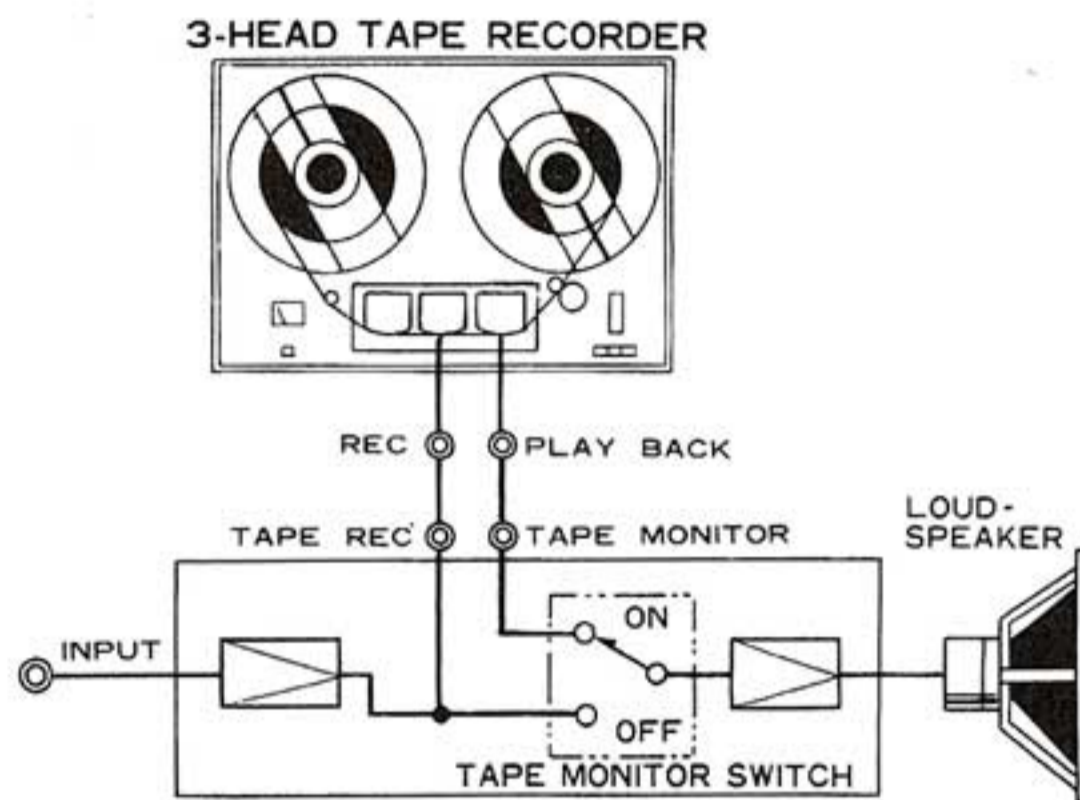

- If the tape recorder to be used has independent erase, recording and playback heads, and in addition, built-in recording amplifiers and playback equalizers, connect it to the SA-900 as illustrated. Then, when the TAPE MONITOR switch (11) is turned ON, the signal immediately after it is recorded on the tape is supplied to the SA-900 through the playback head of the tape recorder and is reproduced through loudspeakers. With the switch turned OFF, the signal before being recorded on the tape is reproduced. Thus the quality of recording performance can be monitored by turning the switch on and off repeatedly while making a recording.

PRE OUT/MAIN IN TERMINALS AND PRE & MAIN SWITCH

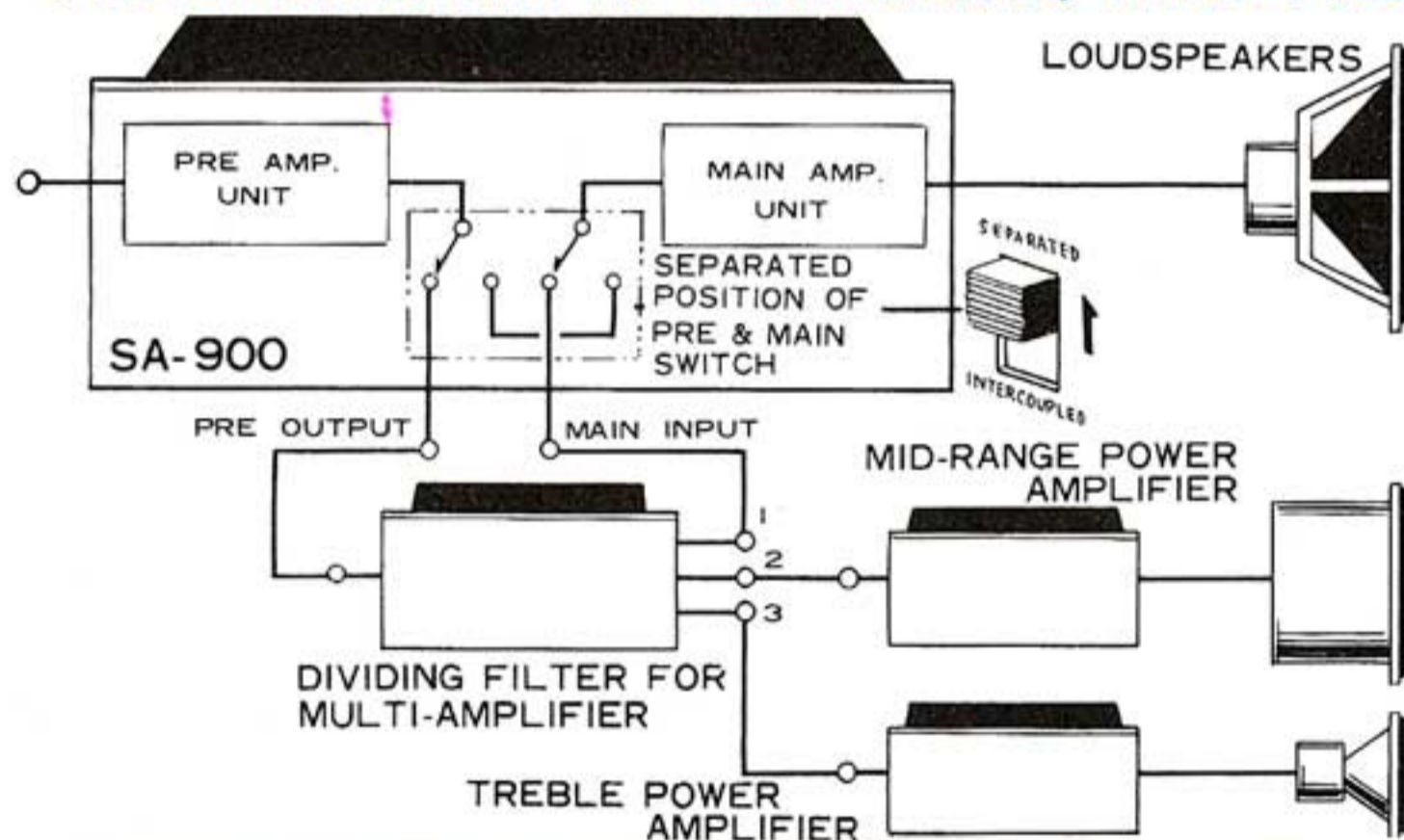

- The preamplifiers unit and main amplifiers unit of the SA-900 can be used separately by setting the PRE & MAIN switch (27) to the SEPARATED position, in order to compose the stereo systems as described below. For ordinary operation, set the PRE & MAIN switch to the INTERCOUPLED (lower) position. The leads connected to the PRE OUT (28) and MAIN IN (29) terminals may be kept connected when the PRE & MAIN switch (27) is set to INTERCOUPLED.

a. MULTI-AMPLIFIER SYSTEM

A high-performance multi-amplifier system can be composed by using a two- or three-division filter and one or two power amplifiers separately available.

b. INTEGRATE STEREO SYSTEM

A high-performance integrated stereo system can be composed by connecting PIONEER's IS-60, IS-70 or IS-80, separately available, to the PRE OUT terminals (28).

CENTER CHANNEL OUTPUT TERMINAL

- By connecting a bass amplifier having a high-cut filter to the CENTER CHANNEL terminal (30), a 3D stereo system can be composed. The 3D system utilizes the acoustic characteristic that comparatively low-frequency sound is not directional. Signals of right and left channels are mixed together, and signal lower than 150-250 Hz in frequency is separated and amplified by a bass amplifier. For this reason, the 3D stereo system has an advantage in that only one woofer is needed. This is convenient when the listening room is not large enough for a large-size loudspeaker system to be installed.

- If the right and left channel loudspeaker systems are too far from each other when installing the loudspeakers systems in a large room, the hall effect (in which the middle portion of the sound image does not appear) occurs. This hall effect can be eliminated by connecting a center channel amplifier to the CENTER CHANNEL terminal (30) and placing the CENTER CHANNEL loudspeaker system at the center between the right and left channel loudspeaker systems.

PROTECTIVE FUSES

- If loudspeaker terminals are shorted or the SELECTOR or MODE switch is operated while the SA-900 is being used at a high sound volume, large current flows in the power transistor which could damage the transistor. Fuses (22) protect power transistors in such cases. When loudspeakers stop sounding while using the SA-900, check these fuses first. If they have blown, locate and repair the cause, then replace them with accessory fuses.



SPECIFICATIONS

• TRANSISTORS AND DIODES

F.E.T.	2
Transistors	29
Diodes	7

• AUDIO SECTION

Circuitry	Single ended push pull
Music Power	4 Ω 200-watt total (H.D. 0.3 %)
(IHF rating)	8 Ω 145-watt total (H.D. 0.3 %)
Continuous Power	4 Ω 64-watt + 64-watt (H.D. 0.3 %)
(Both channel driven)	8 Ω 50-watt + 50-watt (H.D. 0.3 %)
Harmonic Distortion	Less than 0.5% (at 1kHz rated output)
	Less than 0.08 % (at 1kHz 45W output)
Frequency Response	± 1 dB, from 25Hz to 40 kHz (Over-all)
Power Bandwidth	15 Hz to 25 kHz (AUX)
Damping Factor	50/8 Ω (at 1 kHz)
Hum & Noise	MAG: better than 80 dB
	AUX: better than 95 dB
Inputs Impedance and Audio Sensitivity	MAGnetic PHONO: M.C. 0.155mV/130 Ω
	M.M. 3.1mV/50k Ω
	CERamic PHONO: 7.1 mv. 100 K Ω
	TAPE HEAD : 1.8 mv. 150 K Ω
	TAPE MONITOR : 180 mv. 200 K Ω
	AUXiliary : 180 mv. 200 K Ω
	MICrophone : 1.9 mv. 50 K Ω
	Tuner : 180 mv. 200 K Ω
Output Terminals and Jacks	Speakers: 4 to 16 ohms
	Stereo headphones jack, Simultaneous tape Recording jacks, equipped with TAPE MONITOR switch, Tape recording/playback jack (DIN type)
	Center Channel output jack, PRE OUT jacks.
Equalization Curves	PHONO : RIAA
	TAPE : NAB
Tone Controls (each channel) (3 dB steps)	BASS: boost 12 dB, cut 9dB (at 100 Hz)
	TREBLE: boost 9 dB, cut 12 dB (at 10 kHz)
Filters	LOW : cut 6dB (at 50 Hz, -12 dB/oct.)
	HIGH : cut 6 dB (at 10 kHz, - 12 dB/oct.)
Loudness Contour	Switchable to ON-OFF boost 14dB at 50 Hz, boost 7 dB at 10 kHz, with VOLUME control set at -40 dB
Muting	Switchable to ON-OFF attenuate - 20dB

• POWER SUPPLY, ETC.

Line Requirements	110/117/130/220/240 volts, (switchable), 50-60 Hz
	330 VA, 290 watts (Max)
	40 VA, 30 watts (Min)
Dimensions	Overall 15-15/16" / 405 mm (width)
	5-1/2" / 140 mm (height)
	13-5/16" / 339 mm (depth)
Weight	Without package 27 lbs. 2 oz. / 12.3 kg
	With package 33 lbs. / 15 kg

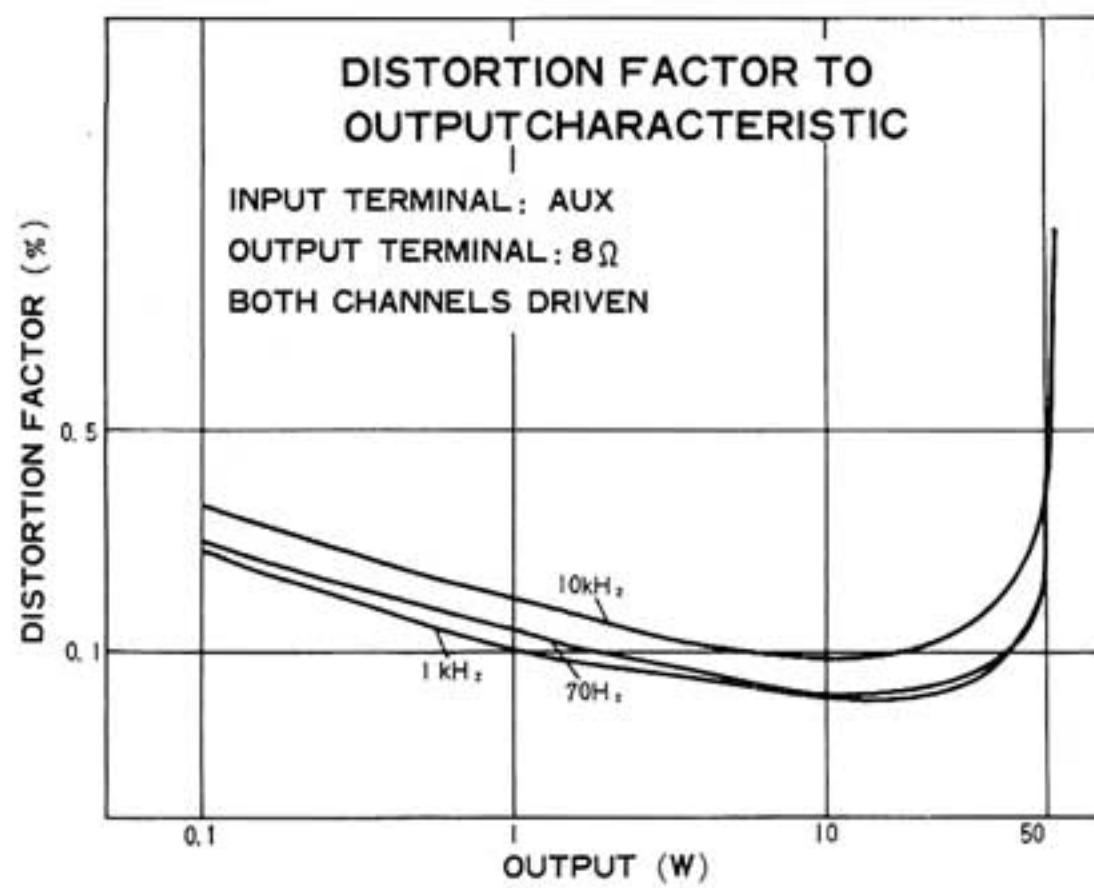
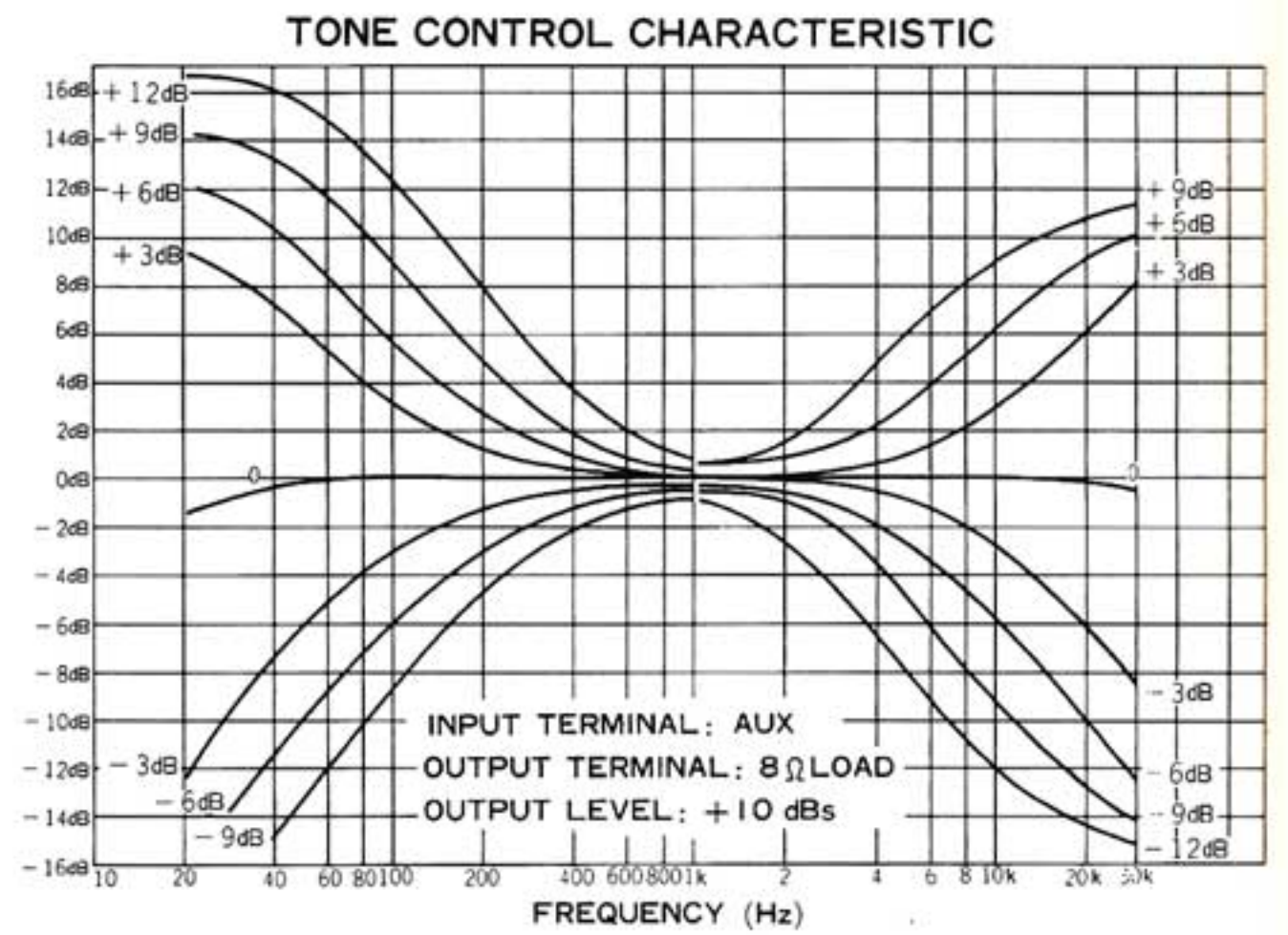
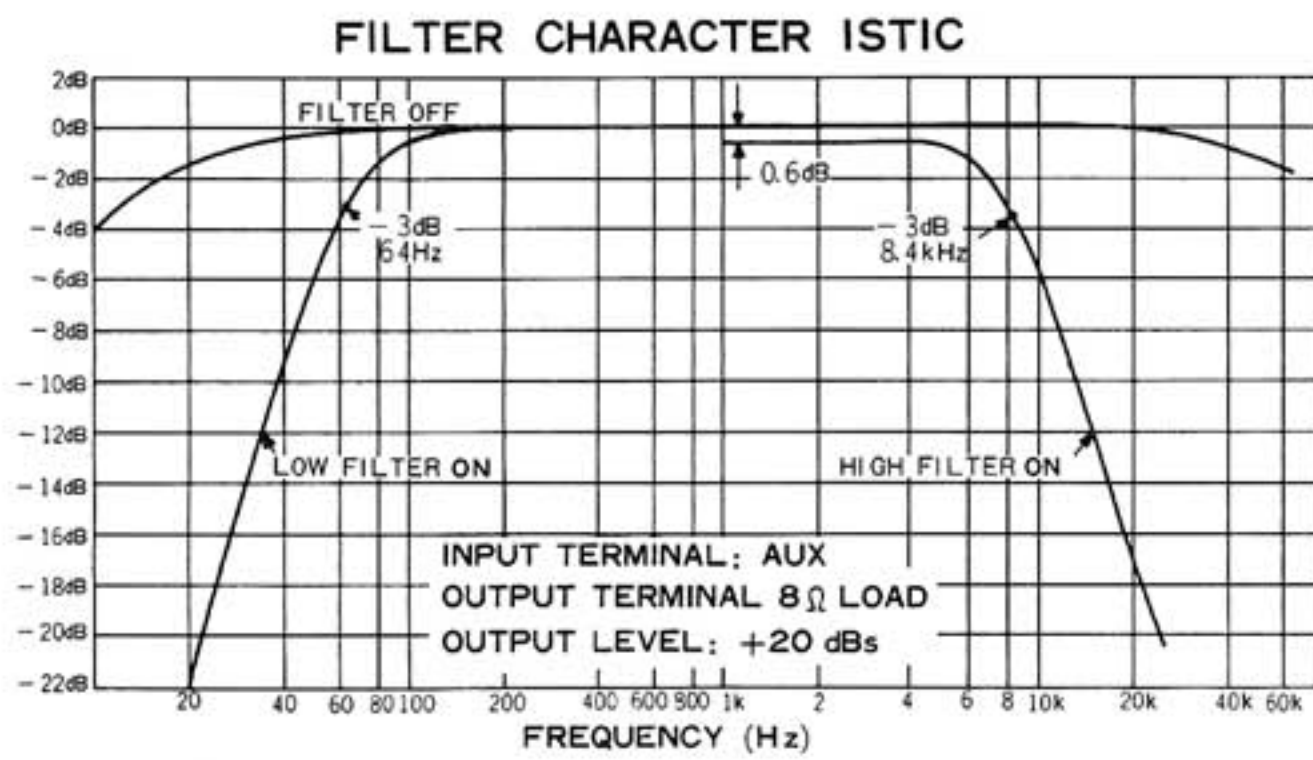
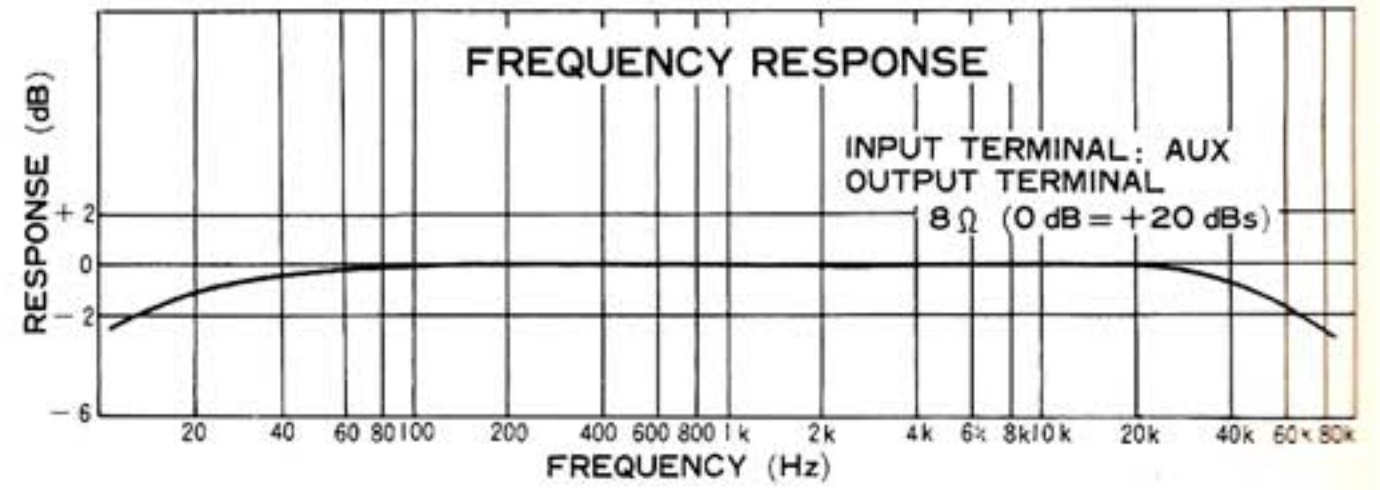
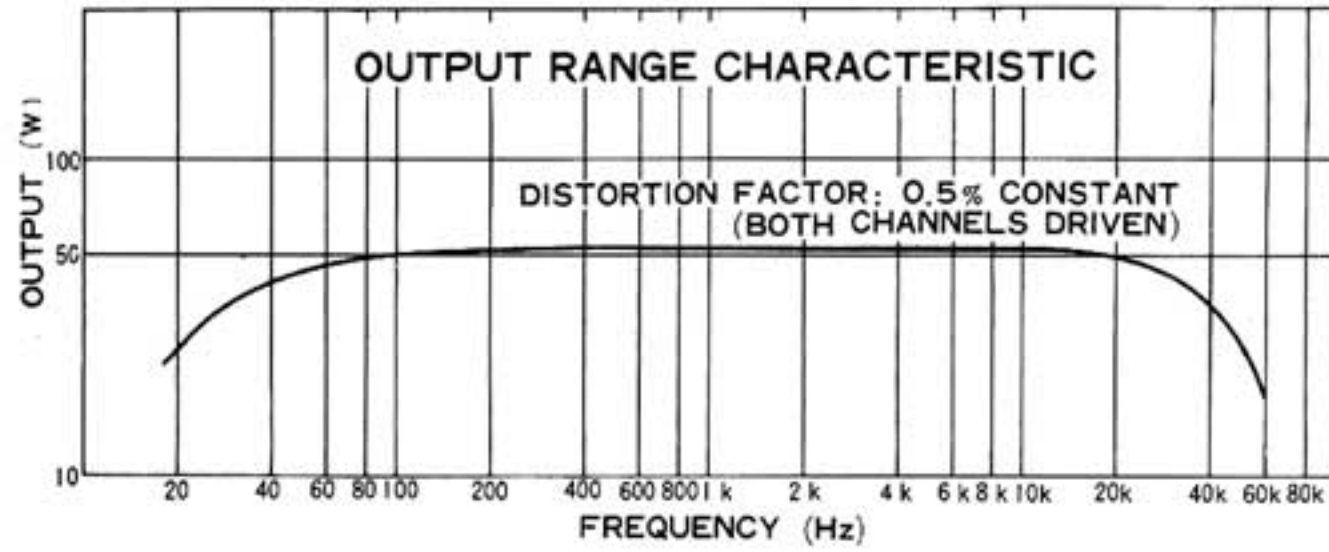

PARTS LIST OF THE SA-900

CAPACITORS

In μF , 10% Tolerance unless otherwise noted
P : $\mu\mu\text{F}$

Symbol	Description			Part No.
C5	Mylar	0.0015	50V	
C6	"	"	"	
C7	Styrol	820p	"	
C8	"	"	"	
C9	Mylar	0.002	"	
C10	"	"	"	
C11	"	0.05	"	
C12	"	"	"	
C13	"	0.025	"	
C14	"	"	"	
C15	"	0.015	"	
C16	"	"	"	
C17	"	0.03	"	
C18	"	"	"	
C19	"	0.05	"	
C20	"	"	"	
C21	"	0.012	"	
C22	"	"	"	
C23	"	"	"	
C24	"	"	"	
C25	"	0.022	"	
C26	"	"	"	
C27	Styrol	820p	"	
C28	"	"	"	
C29	"	"	"	
C30	"	"	"	
C31	"	0.0012	"	
C32	"	"	"	
C33	Mylar	0.002	"	
C34	"	"	"	
C35	Electrolytic	1000	"	C52-041-A
C36	"	"	"	"
C37	"	2200	100V	C52-070-0
C38	"	470	"	C52-069-0
C41	Ceramic	0.01	+80% -20% D.C.1.4KV	C43-003-0
C42	"	"	"	"
C43	"	"	"	"
C44	"	"	"	"
C45	"	"	50V	"
C46	"	"	"	"
C47	"	"	"	"

RESISTORS

In Ohm, 10% Tolerance unless otherwise noted
K : K Ω , M : M Ω , LN : Low Noise

Symbol	Description			Part No.
R1	Carbon film (LN)	68K	1/4W	
R2	"	"	"	
R3	"	1M	"	
R4	"	"	"	
R5	"	100K	"	
R6	"	"	"	
R7	"	68K	"	
R8	"	"	"	
R9	"	330K	"	
R10	"	"	"	
R11	"	100K	"	
R12	"	"	"	
R13	"	47K	"	
R14	"	"	"	
R17	Carbon film	3.3K	"	

R18	"	"	"	"
R19	"	120K	"	"
R20	"	"	"	"
R21	Carbon film (NL)	330K	1/4W	
R22	"	"	"	
R23	Carbon film	470K	"	
R24	"	"	"	
R25	"	180K	"	
R26	"	"	"	
R27	"	15K	"	
R28	"	"	"	
R29	"	1.8K	"	
R30	"	"	"	
R31	"	10K	"	
R32	"	"	"	
R33	"	2.2K	"	
R34	"	"	"	
R35	Wire wound	150	4W	
R36	"	"	"	
R37	Carbon film	1K	1/2W	
R38	"	"	"	
R39	"	22	1/4W	
R40	"	3.3K	"	
R41	"	"	"	
R50	"	47K	"	
R51	"	"	"	

TRANSFORMERS

Symbol	Description	Part No.
	Power Transformer	T52-148-B

POTENTIOMETERS

Symbol	Description	Part No.
VR1	500K Ω Dual. VOLUME Control	C85-054-0
VR2	500K Ω Dual. BALANCE Control	C85-048-B

SWITCHES

Symbol	Description	Part No.
S1	INPUT Selector	S13-025-0
S2	MODE Selector	S14-035-0
S3	BASS Control Switch(L)	S15-033-A
S4	" (R)	"
S5	TREBLE Control Switch(L)	S15-034-A
S6	" (R)	"
S7	SPEAKER Selector	S12-011-0
S8	SLIDE Switch	S41-025-0
S9	TAPE MONITOR Switch	S42-006-A
S13	MUTING Switch	"
S14	SLIDE Switch	S41-025-0
S15	POWER Switch	S11-024-0
	LINE VOLTAGE Selector	S11-018-0

MISCELLANEOUS

Symbol	Description	Part No.
	MC AMP Unit	W15-058-0

HEAD AMP Unit	W15-056-A
CONTROL AMP Unit	W15-050-0
FILTER Unit	W15-059-0
MAIN AMP Unit	W15-052-A
POWER SUPPLY Unit	W16-017-0
DEMI-SWITCH Unit	W15-069-0
Front Panel	M21-269-B
Metal case	M33-113-A
Screw, to fix Metal case	B11-005-A
Foot	M61-017-0
Knob, Tape Monitor, Muting	A12-065-0
Knob, Volume, Selector, Mode	A12-142-B
Knob, Bass, Treble (L,R)	A12-120-A
Knob, Balance, Speaker Selector, Power	A12-144-A
Knob, Loudness, Low filter, High filter	A19-077-0
Pilot Lamp	E22-006-0
Lense for Pilot Lamp	A62-045-0
Pilot Lamp Socket	K42-003-0
Fuse 3A	E21-006-0
Fuse 1.5A	E21-012-0
Fuse Holder	K91-005-0
Headphone Jack	K72-021-0
Tape REC/P.B. Connector	K93-003-B
Jack for microphone	K72-024-0
Speaker Plug	K72-007-B
Spare A.C.Outlet	K32-007-B
Terminal 1p	K21-005-C
Terminal 2p	K21-009-C
Terminal 4p	K22-010-A
Terminal 6p	K22-013-C

TRANSISTORS

Symbol	Description	Part No.
Q1	2SC871	
Q2	"	

HEAD AMP UNIT (W15-056)

CAPACITORS

Symbol	Description			Part No.
C1	Electrolytic	2.2	50V	
C2	"	"	"	
C3	"	10	10V	
C4	"	"	"	
C5	"	"	25V	
C6	"	"	"	
C7	Ceramic	100p	50V	
C8	"	"	"	
C9	"	330p	"	
C10	"	"	"	
C11	Mylar	0.01	"	
C12	"	"	"	
C13	"	0.0033	"	
C14	"	"	"	
C15	"	"	"	
C16	"	"	"	
C17	Electrolytic	220	25V	

MC AMP UNIT (W15-058)

CAPACITORS

Symbol	Description			Part No.
C1	Electrolytic	100	3V	
C2	"	"	"	
C3	Ceramic	100p	50V	
C4	"	"	"	
C5	Electrolytic	100	3V	
C6	"	"	"	
C7	Ceramic	33p	50V	
C8	"	"	"	
C9	Electrolytic	330	16V	
C10	"	"	"	
C11	"	0.47	50V	
C12	"	"	"	

RESISTORS

Symbol	Description			Port No.
R1	Carbon film (LN)	3.3K	1/4W	
R2	"	"	"	
R3	"	470K	"	
R4	"	"	"	
R5	"	1M	"	
R6	"	"	"	
R7	"	470	"	
R8	"	"	"	
R9	"	470K	"	
R10	"	"	"	
R11	"	56K	"	
R12	"	"	"	
R13	"	330K	"	
R14	"	"	"	
R15	"	3.3K	"	
R16	"	"	"	
R17	"	4.7K	"	
R18	"	"	"	
R19	"	10K	"	
R20	"	"	"	
R21	"	47K	"	
R22	"	"	"	
R23	"	270K	"	
R24	"	"	"	
R25	"	27K	"	
R26	"	"	"	
R27	"	2.2K	"	
R28	"	"	"	
R29	"	2.2M	"	
R30	"	"	"	
R31	"	15K	"	
R32	"	"	"	
R33	"	47K	"	
R34	"	"	"	
R35	"	3.9K	"	
R36	"	820K	"	
R37	"	"	"	

RESISTORS

Symbol	Description			Port No.
R1	Carbon film (LN)	2.2K	1/4W	
R2	"	"	"	
R3	"	100	"	
R4	"	"	"	
R5	"	1K	"	
R6	"	"	"	
R7	"	10K	"	
R8	"	"	"	
R9	"	4.7K	"	
R10	"	"	"	
R11	"	47K	"	
R12	"	"	"	
R13	"	4.7K	"	
R14	"	"	"	
R15	"	10K	"	
R16	"	"	"	
R17	"	100K	"	
R18	"	"	"	

TRANSISTORS

Symbol	Description	Part No.
Q1	2SC871	
Q2	"	
Q3	"	
Q4	"	
Q5	"	
Q6	"	

CONTROL AMP UNIT (W15-050)

CAPACITORS

Symbol	Description				Part No.
C1	Electrolytic	0.1		25V	
C2	"	"		"	
C3	"	30		6V	
C4	"	"		"	
C5	Ceramic	39p		50V	
C6	"	"		"	
C7	Electrolytic	30		6V	
C8	"	"		"	
C9	Ceramic	470p		50V	
C10	"	"		"	
C11	Electrolytic	10		25V	
C12	"	"		"	
C13	"	"		"	
C14	"	"		"	
C15	"	50		"	

RESISTORS

Symbol	Description				Part No.
R1	Carbon film	1K		1/4W	
R2	"	"		"	
R3	"	4.7M		"	
R4	"	"		"	
R5	"	4.7K		"	
R6	"	"		"	
R7	"	1K		"	
R8	"	"		"	
R9	"	39K		"	
R10	"	"		"	
R11	"	8.2K		"	
R12	"	"		"	
R13	"	1.8K		"	
R14	"	"		"	
R15	"	10K		"	
R16	"	"		"	
R17	"	6.8K		"	
R18	"	"		"	
R19	"	120K		"	
R20	"	"		"	
R21	"	330		"	
R22	"	"		"	

TRANSISTORS

Symbol	Description	Part No.
Q1	2SK17(F.E.T)	
Q2	"	
Q3	2SC369 or 2SC458LG-C	
Q4	"	
Q5	"	
Q6	"	

MAIN AMP UNIT (W15-052)

CAPACITORS

Symbol	Description				Part No.
C1	Electrolytic	100		25V	
C2	"	"		"	
C3	"	10		10V	
C4	"	"		"	
C5	"	22		25V	
C6	"	"		"	
C7	"	47		3V	
C8	"	"		"	
C9	Ceramic	100p		50V	
C10	"	"		"	
C11	Electrolytic	100		3V	
C12	"	"		"	
C13	"	"		50V	
C14	"	"		"	
C15	Mylar	0.05	±20%	"	
C16	"	"	"	"	
C17	Ceramic	100p		"	
C18	"	"		"	

RESISTORS

Symbol	Description				Part No.
R1	Carbon film	150K		1/4W	
R2	"	"		"	
R3	"	15K		"	
R4	"	"		"	
R5	"	220K		"	
R6	"	"		"	
R7	"	22K		"	
R8	"	"		"	
R9	"	4.7K		"	
R10	"	"		"	
R11	"	470		"	
R12	"	"		"	
R13	"	150		"	
R14	"	"		"	
R15	"	82K		"	
R16	"	"		"	
R17	"	3.3K		"	
R18	"	"		"	
R19	"	68		"	
R20	"	"		"	
R21	"	4.7K		"	
R22	"	"		"	
R23	"	6.8K		"	
R24	"	"		"	
R25	"	220		"	
R26	"	"		"	
R27	"	10		"	
R28	"	"		"	
R29	"	220		"	
R30	"	"		"	
R31	Wire Wound	0.5		5W	
R32	"	"		"	
R33	"	"		"	
R34	"	"		"	
R35	Carbon film	10		1/2W	
R36	"	"		"	
R37	"	15K		1/4W	
R38	"	"		"	
R39	"	15K		"	
R40	"	"		"	
R41	"	680		"	
R42	"	"		"	

DIODES AND TRANSISTORS

Symbol	Description	Part No.
D1	STV-3 Vari-stor	
D2	"	

Q1	2SC870 Transistor
Q2	"
Q3	2SC627
Q4	"
Q5	2SC484
Q6	"
Q7	2SA484
Q8	"
Q9	2SD218
Q10	"
Q11	"
Q12	"

C13	Mylar	0.0022	50V
C14	"	"	"
C15	Electrolytic	1	25V
C16	"	"	"
C17	"	3.3	"
C18	"	"	"
C19	"	100	35V

POTENTIOMETERS

Symbol	Description	Part No.
VR1	50K Ω -B Semi-fixed	C92-044-0
VR2	"	"
VR3	50 Ω -B Semi-fixed	C92-043-0
VR4	"	"

DEMI-SWITCH UNIT (W15-069)

CAPACITORS

Symbol	Description			Part No.
C1	Ceramic	82p	50V	
C2	"	"	"	
C3	Mylar	0.01	"	
C4	"	"	"	

RESISTORS

Symbol	Description			Part No.
R1	Carbon film	100K	1/8W	
R2	"	"	"	
R3	"	"	"	
R4	"	"	"	
R5	"	"	"	
R6	"	"	"	
R7	"	"	"	
R8	"	"	"	
R9	"	68K	"	
R10	"	27K	"	
R11	"	68K	"	
R12	"	27K	"	

SWITCH

Symbol	Description	Part No.
	DEMI-Switch	S31-014-A

FILTER UNIT (W15-059)

CAPACITORS

Symbol	Description			Part No.
C1	Electrolytic	1	25V	
C2	"	"	"	
C3	"	3.3	"	
C4	"	"	"	
C5	Mylar	0.033	50V	
C6	"	"	"	
C7	"	0.022	"	
C8	"	"	"	
C9	Electrolytic	3.3	25V	
C10	"	"	"	
C11	Mylar	0.0047	50V	
C12	"	"	"	

RESISTORS

Symbol	Description			Part No.
R1	Carbon film	220K	1/4W	
R2	"	"	"	
R3	"	680K	"	
R4	"	"	"	
R5	"	2.2K	"	
R6	"	"	"	
R7	"	15K	"	
R8	"	"	"	
R9	"	68K	"	
R10	"	"	"	
R11	"	220K	"	
R12	"	"	"	
R13	"	680K	"	
R14	"	"	"	
R15	"	2.2K	"	
R16	"	"	"	
R17	"	15K	"	
R18	"	"	"	
R19	"	6.8K	"	
R20	"	"	"	
R21	"	"	"	
R22	"	"	"	
R23	"	220K	"	
R24	"	"	"	
R25	"	680K	"	
R26	"	"	"	
R27	"	2.2K	"	
R28	"	"	"	
R29	"	15K	"	
R30	"	"	"	
R31	"	22K	"	
R32	"	"	"	
R33	"	2.2K	"	
R34	"	"	"	
R35	"	1K	"	

TRANSISTORS

Symbol	Description	Part No.
Q1	2SC871	
Q2	"	
Q3	"	
Q4	"	
Q5	"	
Q6	"	

POWER SUPPLY UNIT (W16-017)

CAPACITORS

Symbol	Description			Part No.
C1	Ceramic	0.01	+80% -20% D.C1.4KV	C43-003-0
C3	Electrolytic	100	50V	
C5	"	220	25V	

RESISTORS

Symbol	Description			Part No.
R1	Carbon film	1K	1/4W	

R2	Carbon film	150K		1/4W
R3	"	680		2W
R4	"	33K		1/4W
R5	"	330K		"
R6	"	15K		"
R7	"	3.9K		"
R8	"	33K	5 %	"
R9	"	18K	"	"
R10	"	1.2K	"	"

DIODES AND TRANSISTORS

Symbol	Description	Part No.
D1	SR1DM-8 or 1S1073 Diode	
D2	"	
D3	"	
D4	"	
D5	1S338Q Zener Diode	
Q1	2SC485 Transistor	
Q2	2SC486 "	
Q3	2SC905 "	

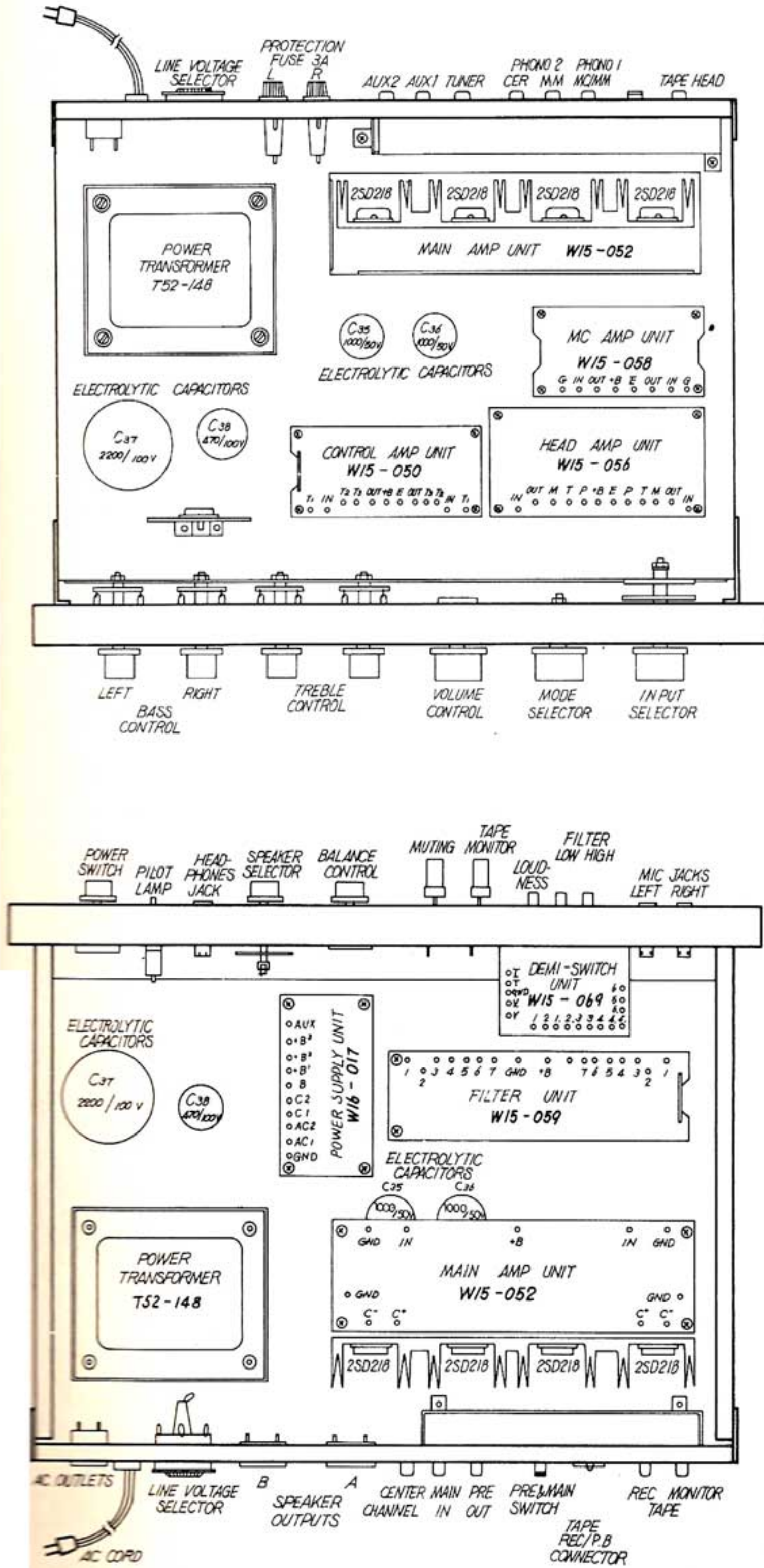

POWER SUPPLY UNIT

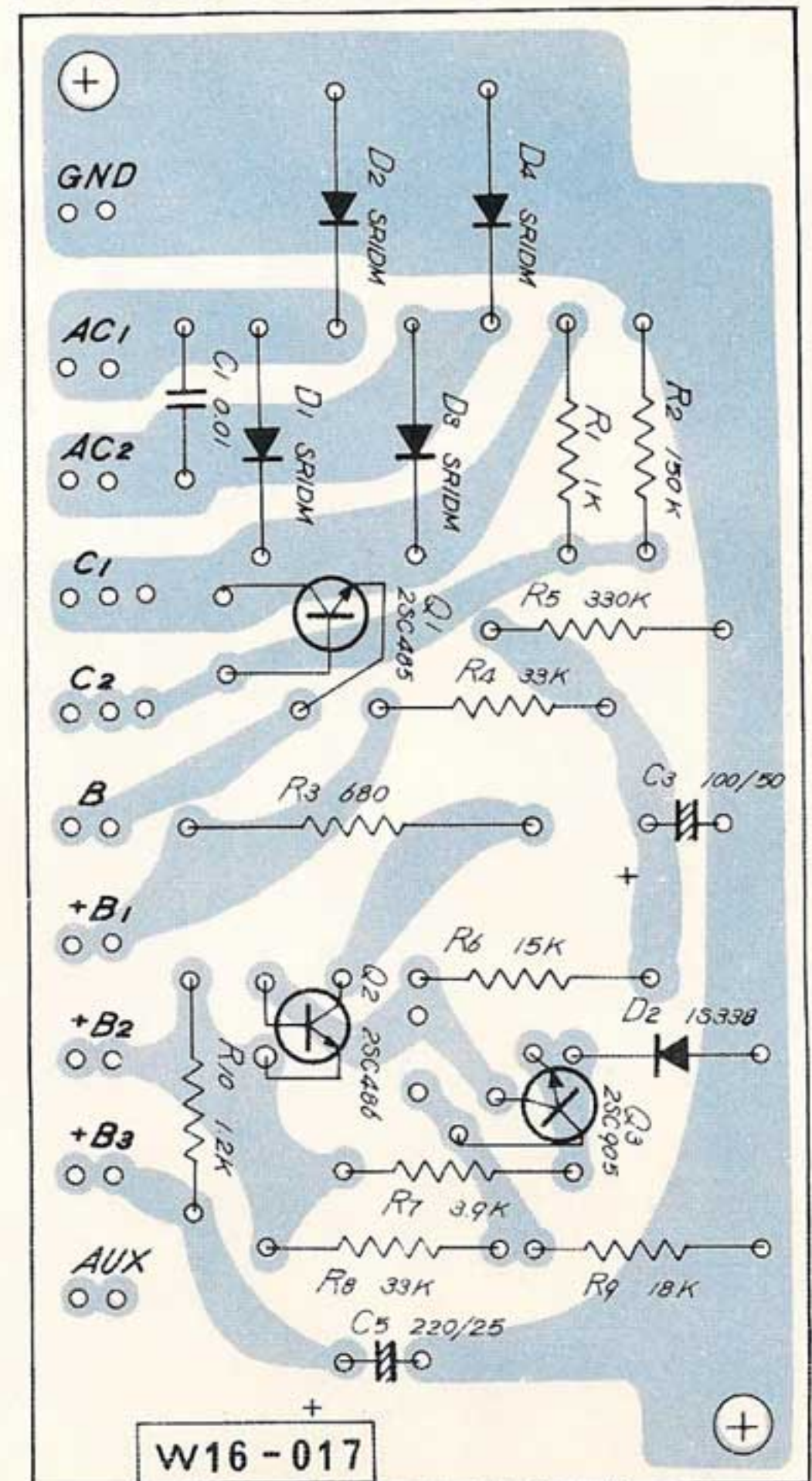

MAIN AMP UNIT

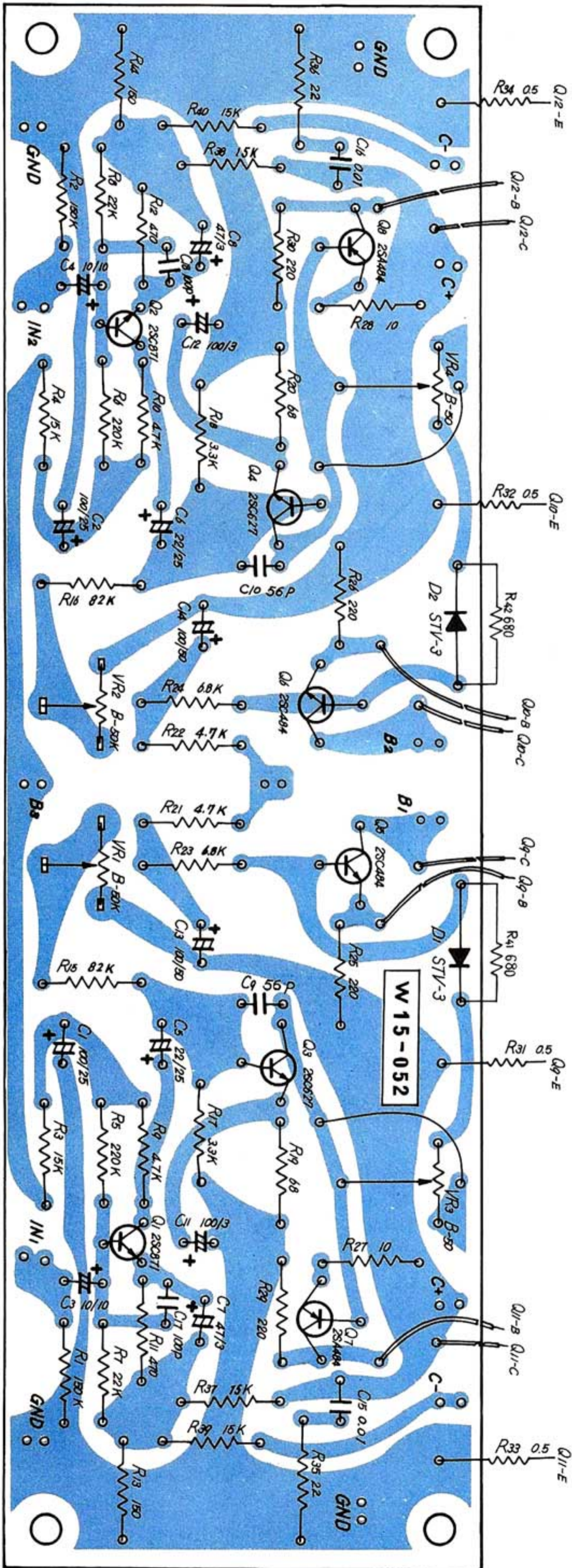

FILTER UNIT

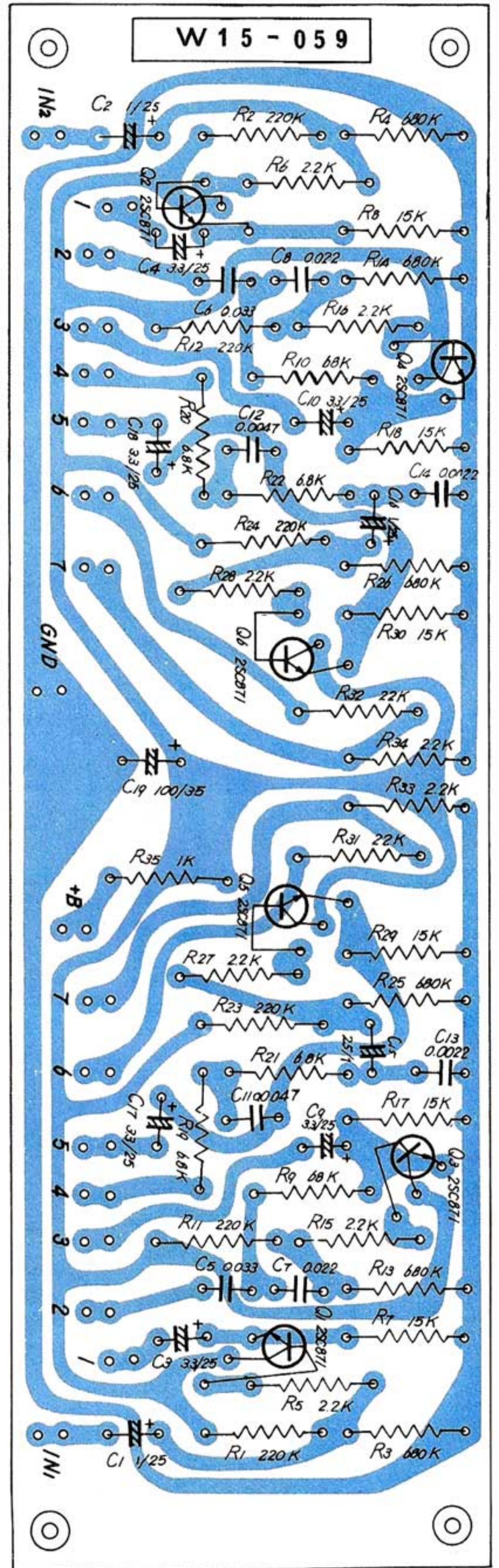

HEAD AMP UNIT

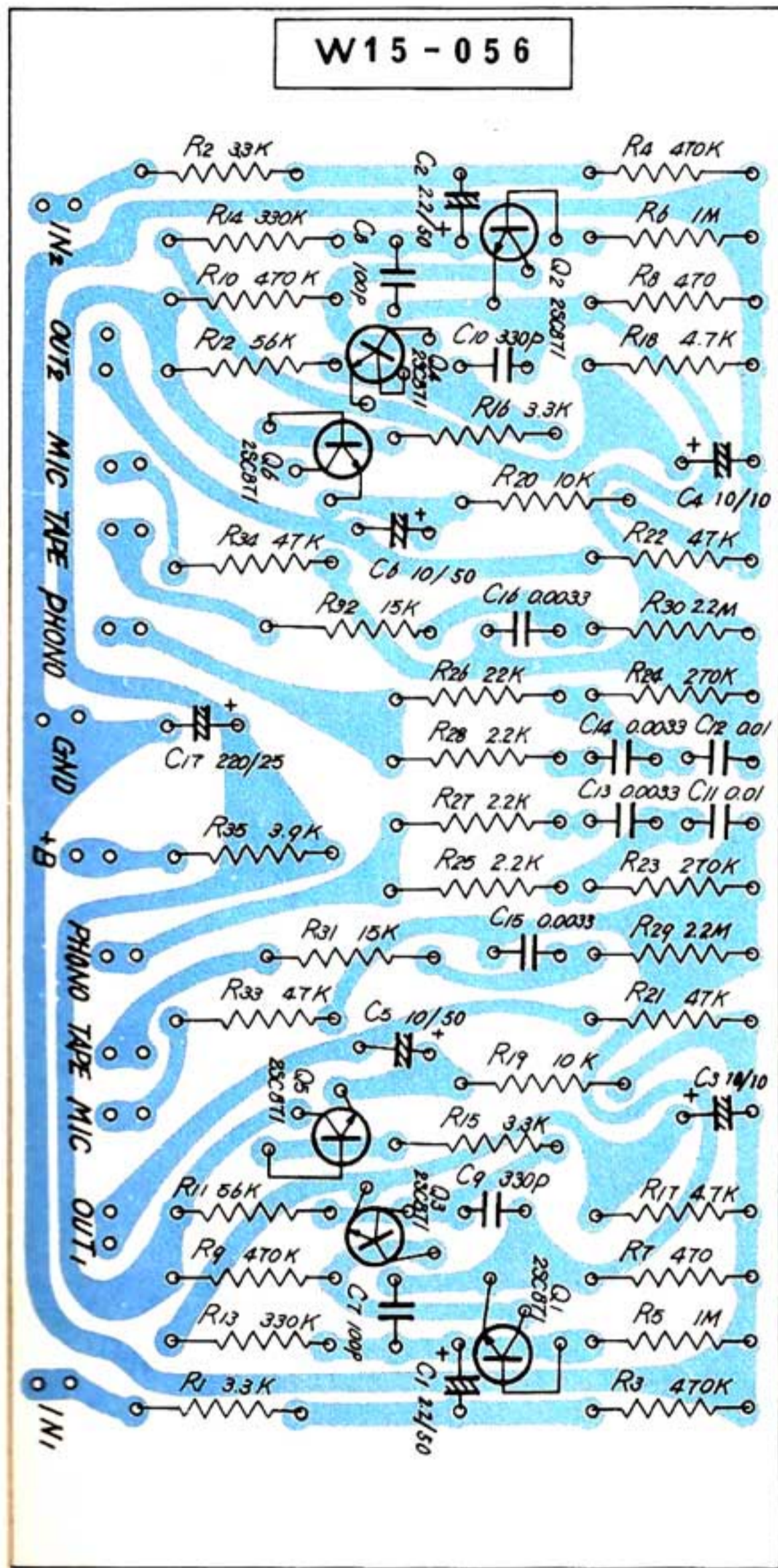

SWITCH UNIT

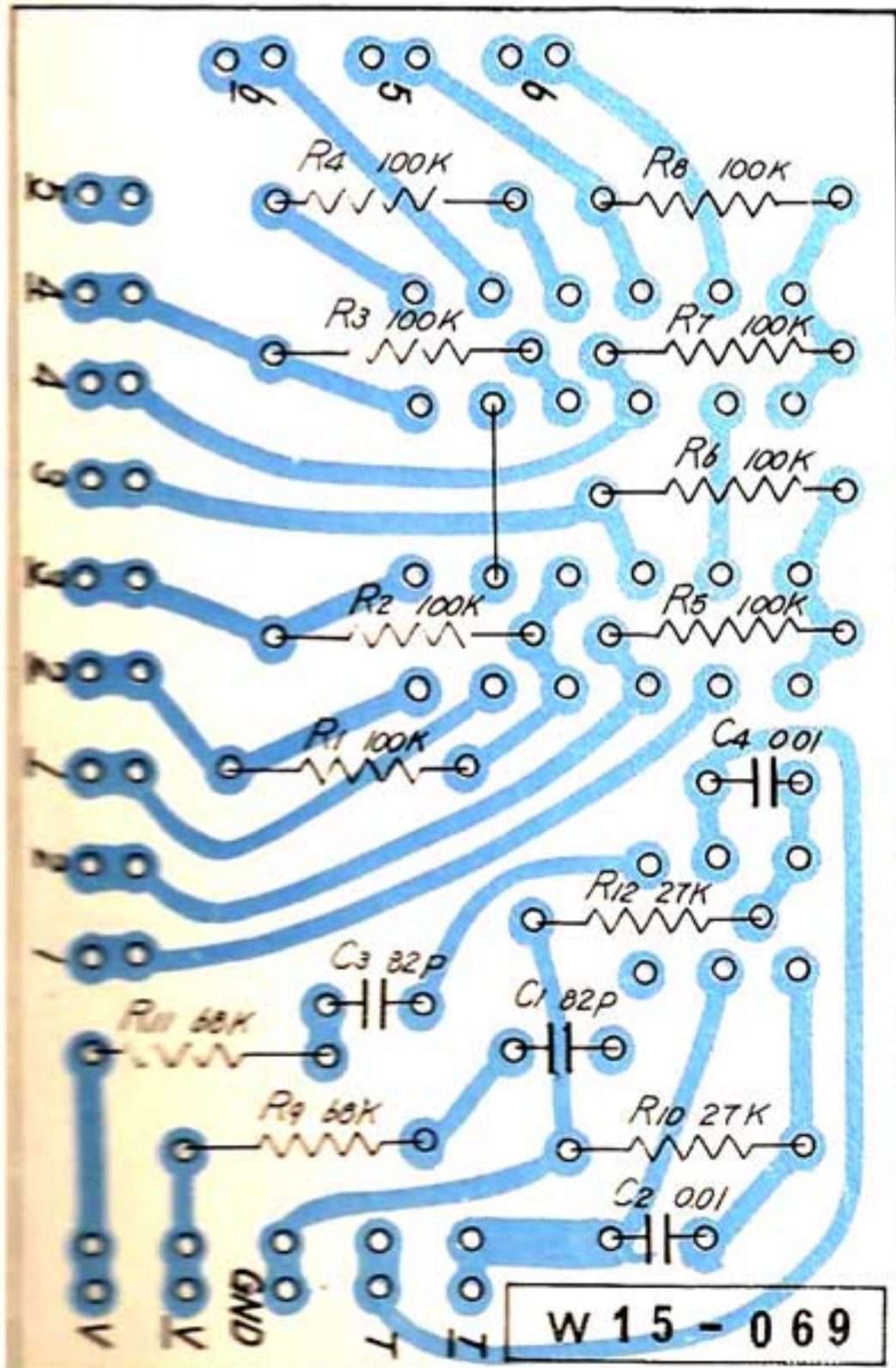

CONTROL AMP UNIT

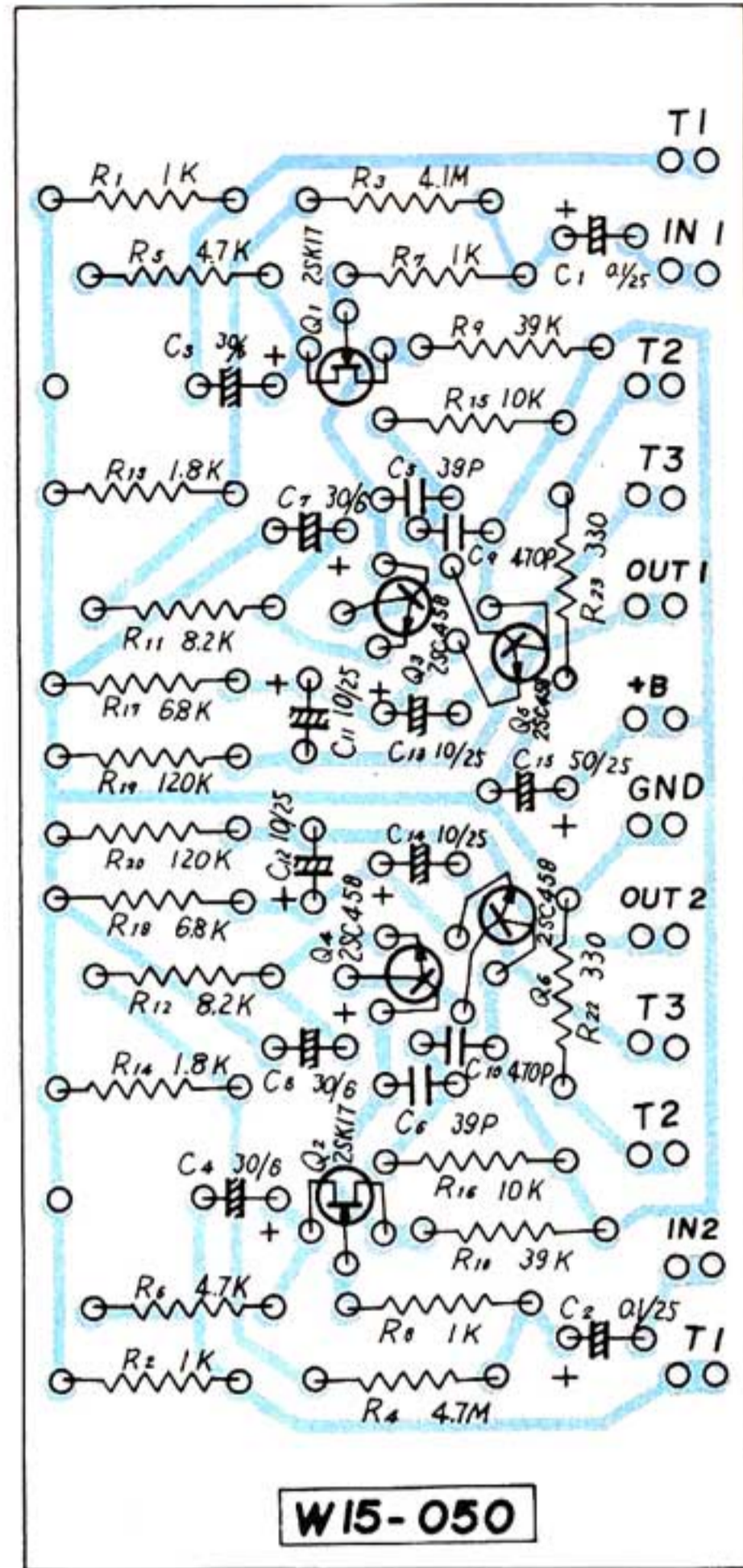

MC AMP UNIT

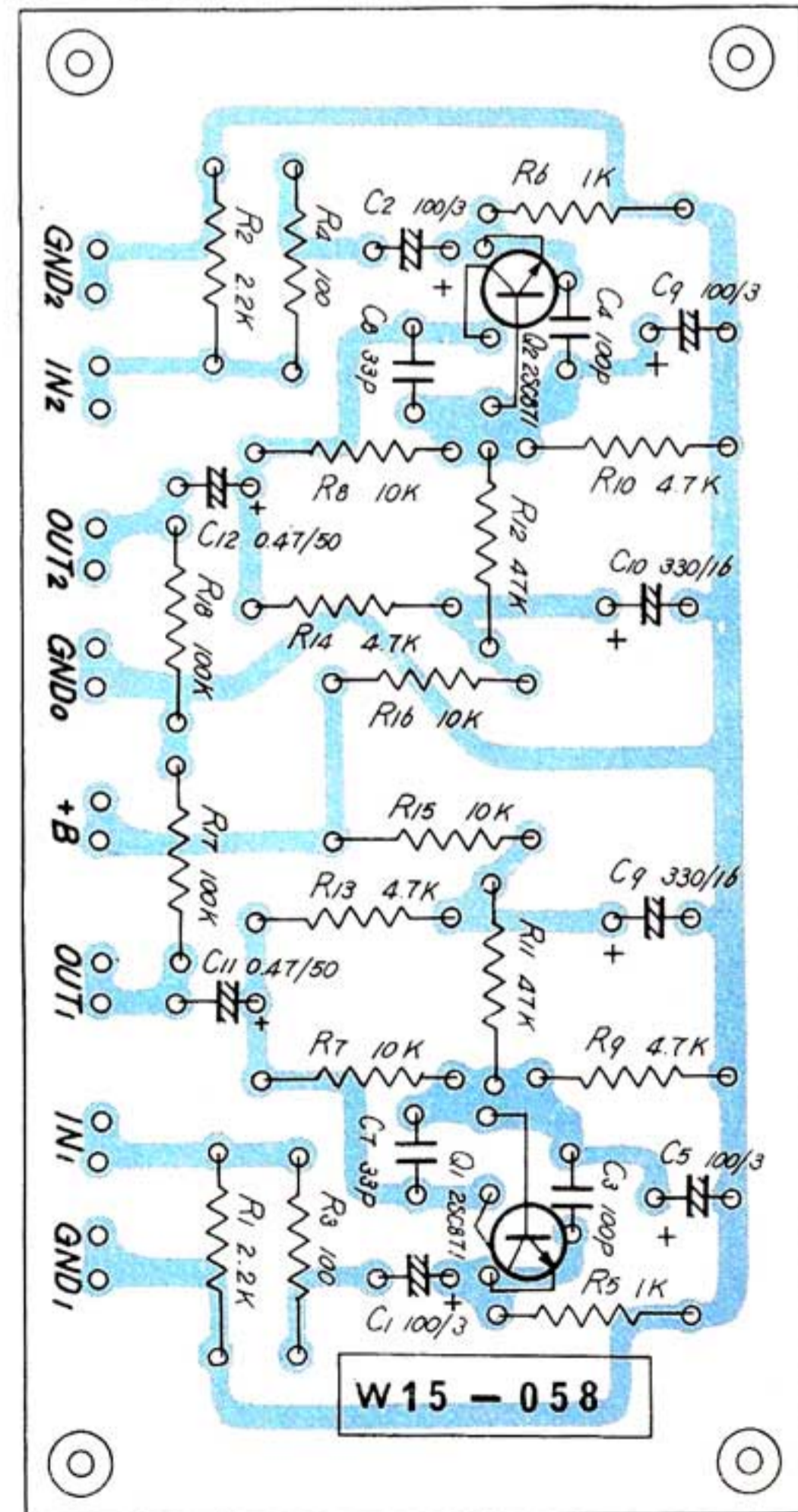

PIONEER



PIONEER ELECTRONIC CORPORATION

15-5, 4-Chome, Ohmori-nishi, Ohta-ku, Tokyo, Japan

PIONEER ELECTRONICS U.S.A. CORPORATION

140 Smith St., Farmingdale, L.I., N.Y. 11735, U.S.A.

PIONEER ELECTRONIC EUROPE AG.

59, Forch Strasse, 8032 Zurich, Switzerland